

NRSTM

National Recreation Systems

A PLAYCORE Company

ALUMINUM BLEACHERS

PLAYER BENCHES • PICNIC TABLES • RENOVATIONS • INSTALLATION



BENCHES



TABLES

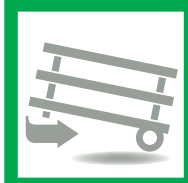

PORTABLE SEATING

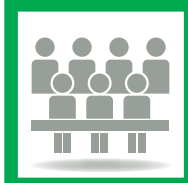

GROUP SEATING



ACCESSIBLE SEATING

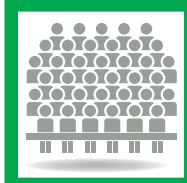

CAPACITY SEATING

NRSTM

National Recreation Systems

A **PLAYCORE** Company

Toll Free (888)-568-9064 Fax (260)-482-7449 www.bleachers.net



TRANSPORTABLE & TIP N' ROLL Bleachers



Transportables can be moved from one field to the next. Tip N' Roll Bleachers can be rolled out and positioned when extra event seating is needed.

BENCHES & TABLES Aluminum or Steel Legs

Benches and Tables for parks, schools, or picnic areas can make a perfect sideline for team sports and picnics.



PORTABLE SEATING
Pages 4-5

GROUP SEATING
Pages 6-7, 10-11

Accessible SEATING
Page 11

BENCHES
Pages 14-15

TABLES
Pages 14-15

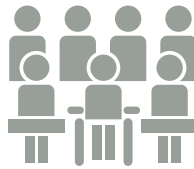
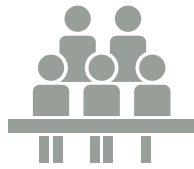

NATIONAL Series Bleachers

Standard, Preferred, and Deluxe Model Bleachers.



ACCESSIBLE Bleachers



ADA Series bleachers feature wheelchair seating areas with companion seating to meet ADA accessibility requirements.



Manufacturer of Quality

ALUMINUM BLEACHERS, BENCHES & PICNIC TABLES

For Over 20 Years



The good news is that about half of all the aluminum used in the United States is being recycled these days. A lot of **energy is saved** in the recycling process - since it avoids the need to make new aluminum from raw ore. National Recreation Systems has created sustainable designs that use the highest aluminum content commercially available.

NON-ELEVATED Bleachers

"Non-Elevated Bleachers" is a term used to describe a type of bleacher where feet rest at ground level on the first row of seats.

Rows	Depth	Height
5	9' 4"	7' 10"
8	15' 4"	9' 10"
10	19' 4"	11' 2"
12	23' 4"	12' 6"
13	25' 4"	13' 2"
15	29' 4"	14' 6"
20	39' 4"	17' 10"

Dimensions are approximate

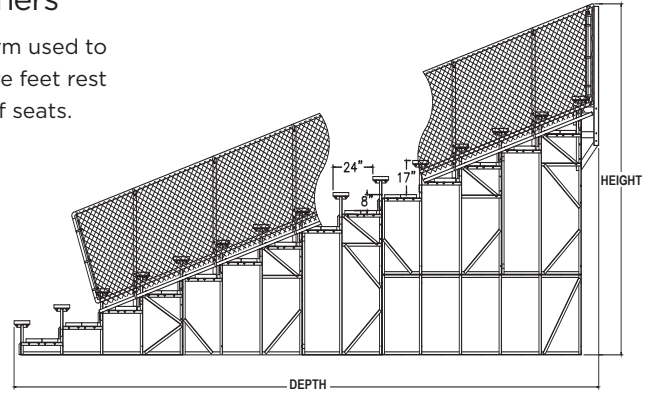

ELEVATED Bleachers

"Elevated Bleachers" is a term used to describe a type of bleacher where feet rest at the height of the elevated front walkway on the first row seats. Several elevation heights are available. These elevations require entry stairs and front guardrail. An accessible ramp may also be required with ADA seating.

Rows	Depth	Height
5	15' 2"	10' 10"
8	21' 2"	12' 10"
10	25' 2"	14' 2"
12	29' 2"	15' 6"
13	31' 2"	16' 2"
15	35' 2"	17' 6"
20	45' 2"	20' 10"

Based on a 36" elevated front walkway

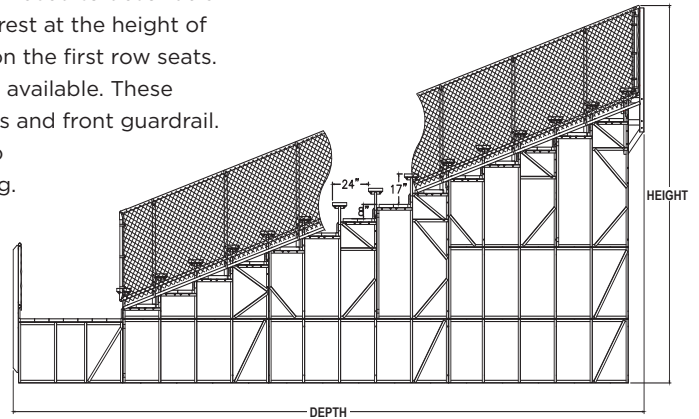

CAPACITY SEATING Pages 8-9

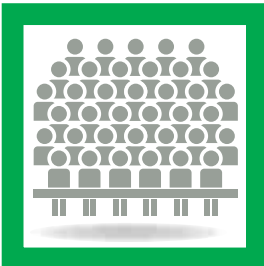

ELEVATED Bleachers

Elevated Bleachers offer better sight lines for viewing the action.



TIP N' ROLL Bleachers

Model	Seats	Length	Riser	Guardrail
TR-0215STD	20	15"	no	no
TR-0315STD	30	15"	no	no
TR-0415ALRSTD	40	15"	no	no

Other Sizes Available

2, 3 & 4-Row Tip N' Roll Bleachers

Tip N' Roll Bleachers can be rolled out and positioned when extra event seating is needed. Non-marring rubber foot pads are standard to protect floors. Available as:

- **Standard Model** (1) single 2"x10" mill finish foot plank
- **Preferred Model** (2) double 2"x10" mill finish foot planks

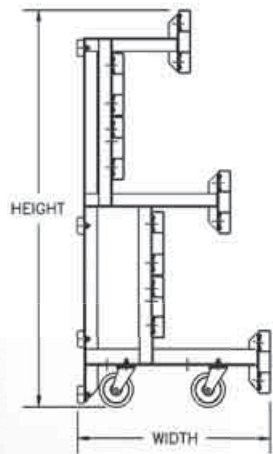

The systems are easily tipped up onto swivel non-marring casters for ease of movement. The aluminum frames reduce weight for easier lifting.



Exclusive **4-Row Outrigger** adds stability when tipped up for movement. (4-Row model only)

Rows	Model	Seat Height	Rise	Seat	Width	Height
2	Tip N' Roll	17"	8"	2x10	2'2"	3'3"
3	Tip N' Roll	16"	6"	2x10	2'5"	5'0"
3	Low Rise Tip N' Roll	12"	6"	2x12	2'0"	4'2"
4	Low Rise Tip N' Roll	12"	6"	2x12	2'6"	7'1"

Always check with your local building department for applicable codes. All bleachers should be properly anchored to resist wind loads.



3-Row Preferred Model Bleacher

- (2) double 2"x10" foot planks



4-Row Preferred Model Bleacher

- (2) double 2"x10" foot planks

TRANSPORTABLE Bleachers

Model	Seats	Length	Aisle	Guardrail
NB-0515ATPSTD	50	15"	no	yes
NB-0521ATPPRF	70	21"	no	yes
NB-0524ATPDLX	68	24"	yes	yes
NB-1015ATPSTD	100	15"	no	yes
NB-1021ATPPRF	140	21"	no	yes
NB-1024ATPDLX	133	24"	yes	yes

Other Sizes Available



TIP N' ROLL & TRANSPORTABLE BLEACHERS

- Available as: **Standard**, **Preferred**, or **Deluxe** models (Refer to pages 6-7 for features).
- 15' systems are available as **Standard** or **Preferred** models only.



5-Row Deluxe Model Transportable Bleacher



Light-Duty Transport Kit

Required with 5 row systems. Includes: Wheel, Mechanical Jack, and Tongue Assembly. One kit can be purchased to move multiple Transportable Bleachers.

- **5-Row** - Requires light-duty transport kit
- **10-Row** - Requires heavy-duty transport kit

5 & 10-Row Transportable Bleachers

The Transportable Bleachers are designed to withstand the rigors of movement (each Transportable Bleacher is fitted with additional horizontal steel lifting brace and additional cross bracing for added structural support). Available with galvanized steel or aluminum frames, and includes ground sills.



Heavy-Duty Transport Kit

Required with 10-Row systems. Includes: Wheels, Integrated Hydraulic Jack, and Tongue Assembly.

- **5-Row** - Requires light-duty transport kit
- **10-Row** - Requires heavy-duty transport kit



10-Row Deluxe Model Transportable Bleacher



The **Smart Solution** for the budget-minded
Transport from one location to the next!

NATIONAL

Series Bleachers

Standard Model Quality and Value

Model	Description	Length	Seating Capacity	Guardrail
NB-0315ASTD	3-Row Standard	15'	30	no
NB-0515ASTD	5-Row Standard	15'	50	yes
NB-1015ASTD	10-Row Standard	15'	100	yes

Other Sizes Available



3-Row Standard with red powder coated seat planks



3-Row Standard Bleacher

3-Row Standard Model Bleachers

- 16" first seat height
- 6" rise per row
- Top seat height under 30"
- 2"x10" anodized seat plank
- (1) 2"x10" mill finish foot plank on rows 2 & 3

Guardrail and riser plank not required by most building and safety codes.



5-Row Standard Bleacher with standard chainlink guardrail

5 & 10-Row Standard Model Bleachers

- 17" first seat height
- 8" rise per row
- 2"x10" anodized seat plank
- Chainlink guardrail system included or Vertical Picket guardrail available
- (1) 2"x10" mill finish aluminum foot plank (rows 2 -3)
- (2) 2"x10" mill finish aluminum foot plank (rows 4 & up)
- (1) 1"x6" riser plank rows 4 & up
- (2) 1"x6" riser plank (top row)

NATIONAL

Series Bleachers

Preferred Model with added footplanks for more secure footing

Model	Description	Length	Seating Capacity	Guardrail
NB-0315APRF	3-Row Preferred	15'	30	no
NB-0515APRF	5-Row Preferred	15'	50	yes
NB-1015APRF	10-Row Preferred	15'	100	yes

Other Sizes Available



5-Row Preferred Bleacher with chainlink guardrail

3, 5 & 10-Row **Preferred Model** Bleachers include all the features of the Standard Models plus...



- (2) 2"x10" mill finish foot plank on rows 2-3 to provide more secure footing



NATIONAL Series Bleachers

Deluxe Model with aisles, double foot plank, and riser plank on all rows

Model	Description	Length	Seating Capacity	Riser Planks	Guardrail
NB-0321ADLX	3-Row Deluxe	21'	36	yes	no
NB-0327ADLX	3-Row Deluxe	27'	48	yes	no
NB-0521ADLX	5-Row Deluxe	21'	58	yes	yes
NB-0527ADLX	5-Row Deluxe	27'	74	yes	yes
NB-1021ADLX	10-Row Deluxe	21'	112	yes	yes
NB-1027ADLX	10-Row Deluxe	27'	144	yes	yes

Other Sizes Available



Deluxe Model Bleacher includes all the features of the Preferred Model plus...



- Aisles with anodized aluminum handrails and contrasting nosing
- 1" x 6" riser plank on all rows



10-Row **Deluxe** Bleacher



5-Row **Deluxe** Bleacher

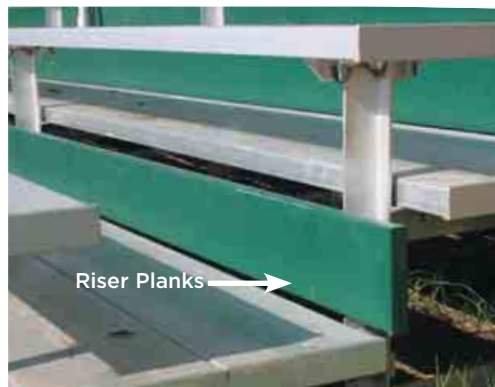

Riser Planks on all rows

OPTIONS for Group Seating



Vertical Picket Guardrail System



Add school colors!

4 stock color planks available in 7.5', 12', 15', and 24' lengths – many other special order colors and lengths available

Most bleacher systems are available with aluminum or galvanized steel angle frames.



Always check with your local building department for applicable codes. All bleachers should be properly anchored to resist wind loads.

ELEVATED Bleachers

For better sight lines when players are on the sidelines or increased viewing of the action, **Elevated Bleachers** are your ticket to the “*Best Seat in the House*”.



Powder Coated Seat and Riser Planks

Elevated Bleachers

- Front walkway with railing
- Chainlink or vertical picket guardrail
- Aisles with anodized aluminum handrail
- Entry stairs with contrasting nosing
- Anodized aluminum seat plank
- (2) 2"x10" mill finish foot plank on all rows
- 1"x6" riser plank on all rows and (2) 1"x6" riser plank on top rows
- Various front walkway elevations available



Always check with your local building department for applicable codes. All bleachers should be properly anchored to resist wind loads.

Common Seating Layouts

Ask your rep about the many other seating layouts available.

Rows	Length	Seats	ADA Seats
5	39'	102	4
5	61'6"	155	5
5	103'6"	283	5
10	91'6"	497	6
10	133'6"	740	8
10	175'6"	983	10
15	91'6"	745	8
15	121'6"	993	10
15	175'6"	1,475	13
20	91'6"	993	10
20	181'6"	1,982	16
20	271'6"	3,034	24

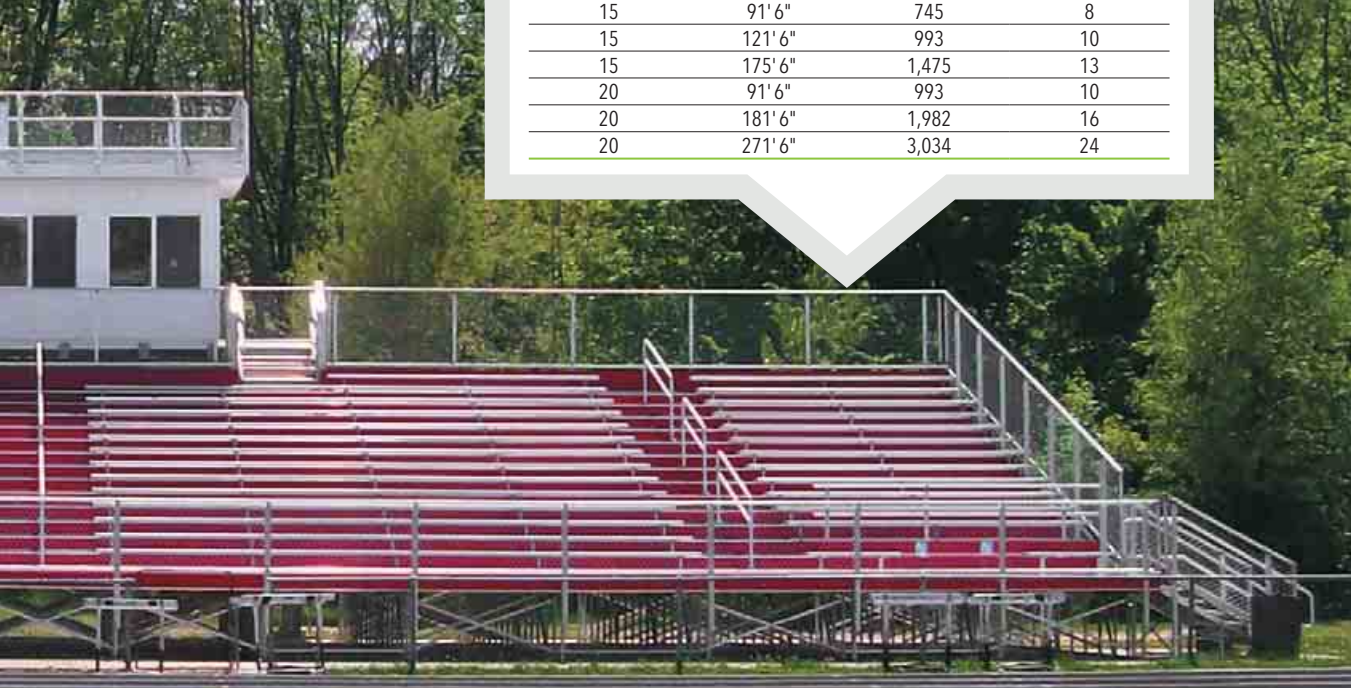

Also Available as Non-Elevated Systems



Aisle with Handrail



Press Box



ADA Accessible Ramp



ADA Wheelchair Section



Entry Stairs



Vertical Picket Guardrail

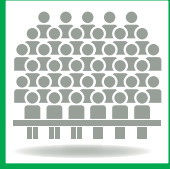

ELEVATED BLEACHERS



LOW RISE Bleachers

Model	Description	Length	Seats	Guardrail	Db'l. Foot Plank
NB-0415ALRSTD	4-Row Low-Rise	15'	40	no	no
NB-0415ALRPRF	4-Row Low-Rise	15'	40	no	yes
NB-0515ALRSTD	5-Row Low-Rise	15'	50	yes	Row 5
NB-0515ALRPRF	5-Row Low-Rise	15'	50	yes	yes



4-Row Low-Rise
"Preferred Model" Bleacher

Standard Model 3 & 4-Row Low-Rise Bleachers

- Top seat height under 30" high
- First seat height under 12" high
- 6" rise/24" run per row
- 2"x12" anodized seat plank (extra wide)
- (1) 2"x10" mill finish foot plank all rows

Standard Model 5-Row Low-Rise Bleachers

includes the same features as the 3-4 row Low-Rise Bleachers Standard Model plus...



- A unique vertical picket guardrail system to comply with code. (Top seat over 30")
- (2) 1"x 6" riser planks on the top row
- (2) 2"x 10" mill finish foot plank on row 5

All sizes are available as **Preferred Models** which include all the same features as the Standard Model



(2) 2"x10" mill finish foot plank on rows 2-3



Always check with your local building department for applicable codes. All bleachers should be properly anchored to resist wind loads.



5-Row Low-Rise "Standard Model"





ADA Series



5-Row x 15'
*Vertical Picket
Guardrail*

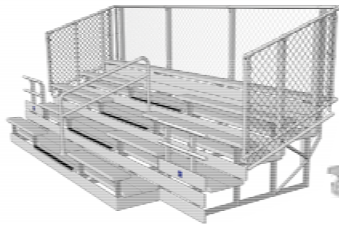

5-Row x 19' 6"
Chainlink Guardrail

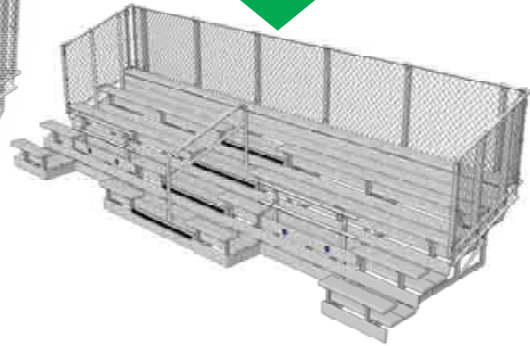

5-Row x 27'
Chainlink Guardrail

ADA Series Bleachers feature wheelchair seating areas with companion seating to meet ADA accessibility requirements. Available with chainlink or vertical picket guardrail.

SUPERIOR SEAT Series



- Seats with back rests for more comfort
- Closed Deck System for easier maintenance
- 14" rise per row for superior line of sight
- 36" run for additional leg room and more comfort
- Aisle with center handrail for easier access to upper rows
- All-aluminum vertical picket guardrail for a safer non-climbable system

CUSTOM Designs

Custom Designed Bleachers are available with many features and options to meet your specific needs. Our in-house design and engineering departments can take your facility seating project from concept to reality - on budget and on time.



LOW-RISE, ADA, & CUSTOM BLEACHERS

BLEACHER COMPONENTS

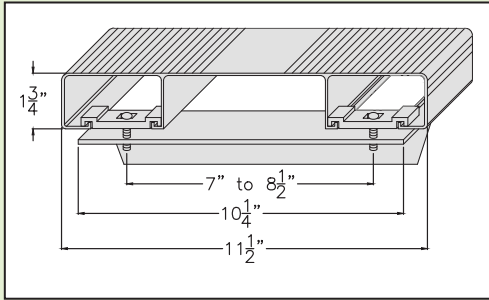

2" x 12"

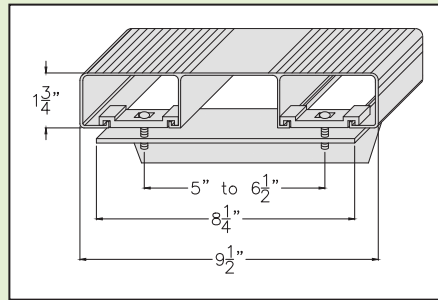

2" x 10"

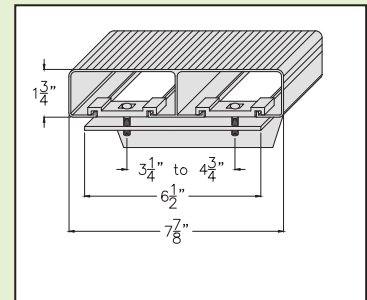

2" x 8"

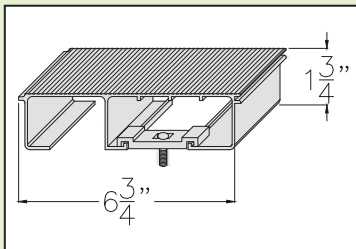

2" x 7"

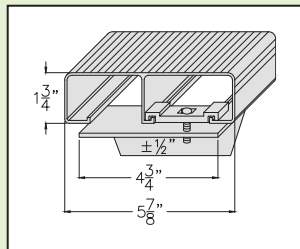

2" x 6"

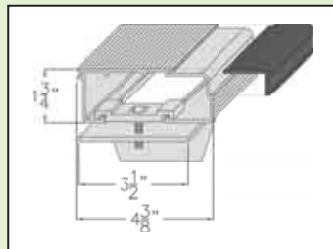

2" x 5" w/nosing

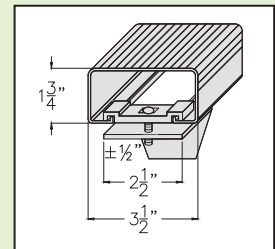

2" x 4"

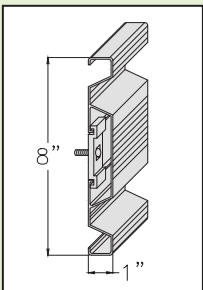

1" X 8"

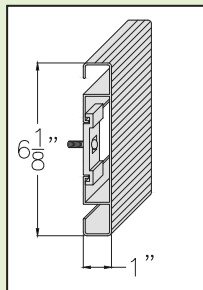

1" X 6"

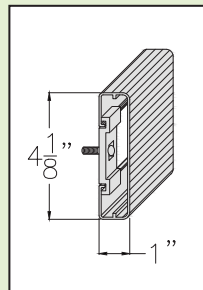

1" X 4"

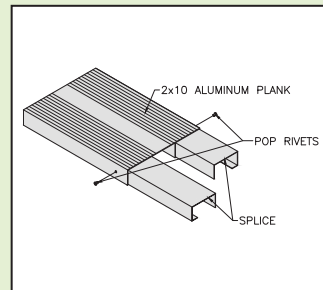

Plank Splice

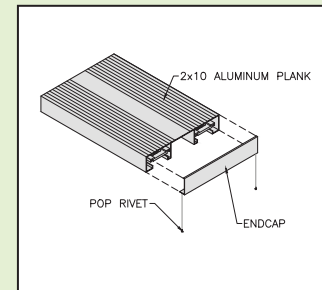

End Cap

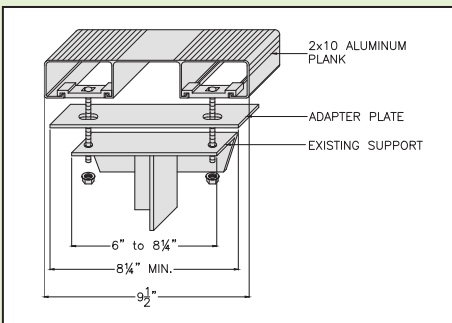

Seat Adapter Plate

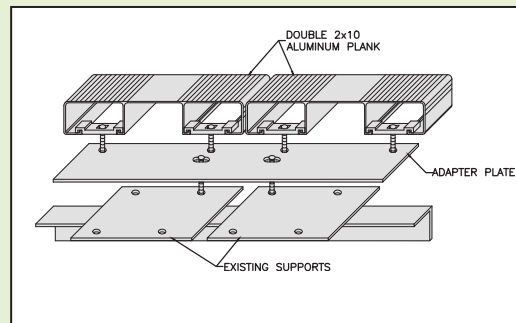

Double Foot Adapter Plate

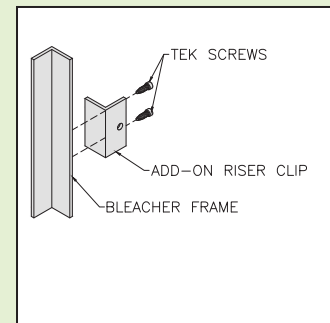

Riser Bracket

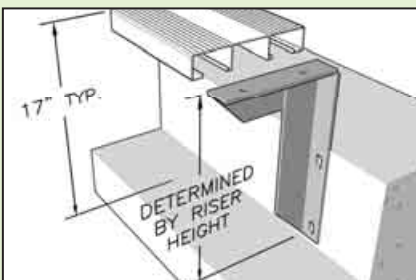

L Bracket

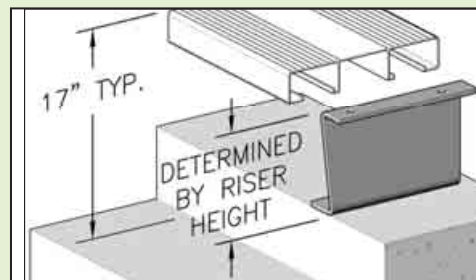

Z Bracket

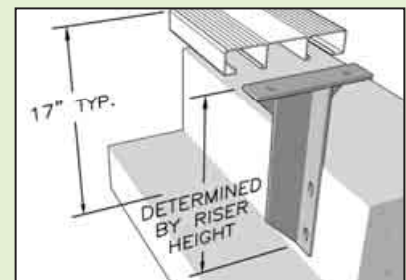

T Bracket

RENOVATIONS

Update existing bleachers to code compliance

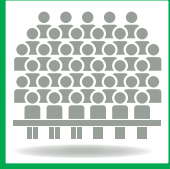

COMPONENTS & RENOVATIONS



Update old non-compliant bleachers to today's building and safety codes and eliminate maintenance of old wood planking.

Many bleachers can be retrofitted using the existing framework by adding maintenance free aluminum planking to replace deteriorated wood planks and close up openings.

From this... **TO THIS!** *All openings closed to less than 4" for compliance*

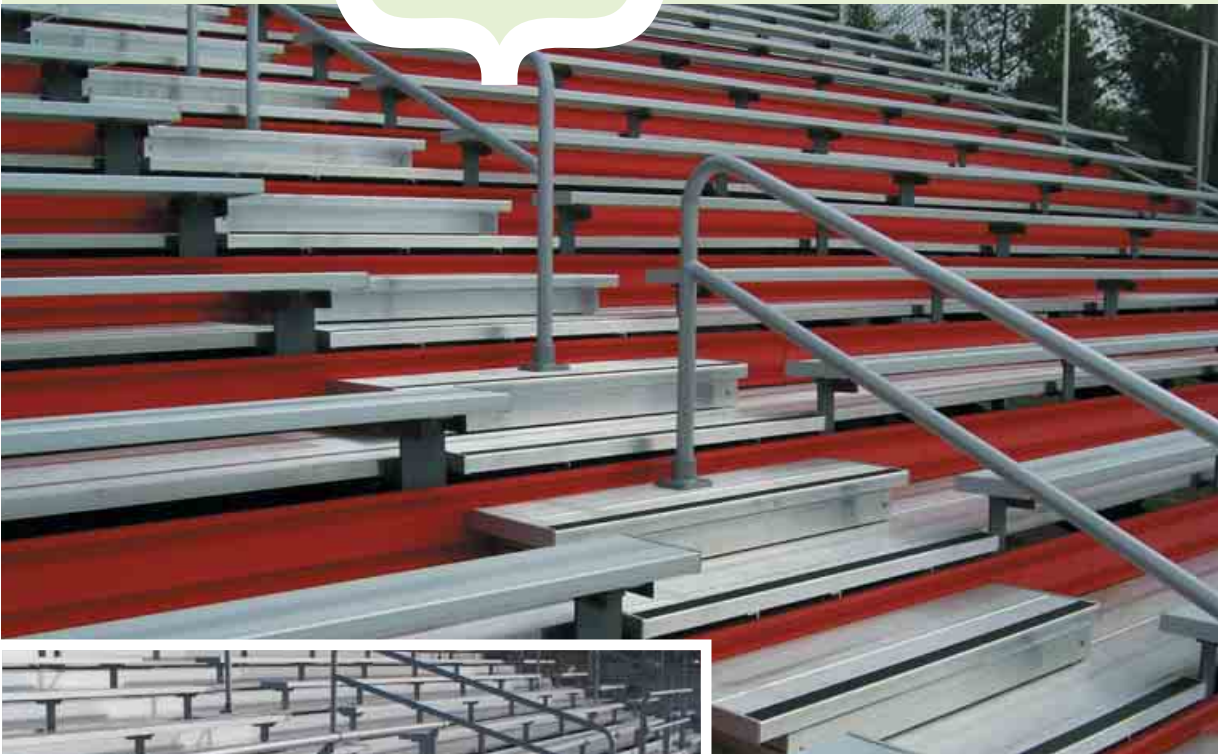

ADA Compliant wheelchair accessibility

OPTIONS

to meet code requirements

- ADA Accessibility
- Guardrails
- Aisles & handrails
- Openings closed to 4" or less
- Number of exits



Add school colors!

many other special order colors available

Toll Free (888)-568-9064 ♦ Fax (260)-482-7449 ♦ Visit us online at www.bleachers.net

Picnic TABLES

Model	Length	Description
PT-AP06	6'	All Anodized Aluminum
PT-AP08	8'	All Anodized Aluminum
PT-AP09HC	9'	All Anodized Aluminum (wheelchair accessible)



All-Aluminum Picnic Table



Aluminum Picnic Table w/ ADA Access

ALUMINUM OR



Optional Powder Coat Plank Colors
available in 7.5' and 15' lengths

All-Aluminum Picnic Tables are lightweight maintenance free aluminum seat and table top with 1-7/8" O.D. anodized aluminum legs. The mechanically fastened assembly allows tables 8' or less to be shipped via parcel service to save on freight costs.

BENCHES

National Recreation Systems' Aluminum Benches are available with Powder Coated seats, backrests and shelves. Add your team colors with our protective Powder Coat to improve appearance or to reduce glare. All Benches are available in 6', 8', 12', 15', 21', and 24'. Some assembly required.

Model	Aluminum Legs
DI	Portable Bench w/o Back
DB	Portable Bench (Dbl. Wide) w/o Back
DG	Portable Bench w/ Back
DGS	Portable Bench w/ Backrest & Shelf
DD	Permanent Bench w/o Back
DE	Locker Room Bench w/o Back



DI Bench



DB Portable Bench (Double Wide)

ALUMINUM OR

Whether it's your local high school football team or the biggest game in pro football...



DG Portable Bench w/ Back shown with optional foot pads



DGS Bench w/ Backrest & Shelf



DD Permanent Bench



DE Locker Room Bench w/o Back shown with optional foot pads



PICNIC TABLES

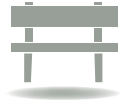

BENCHES

Model	Length	Description
PT-SG06	6'	Standard Gauge Steel Leg Table
PT-SG08	8'	Standard Gauge Steel Leg Table
PT-SG09HC	9'	Standard Gauge Steel Leg Table (ADA Accessible)

Model	Length	Description
PT-HG06	6'	Heavy Gauge Steel Leg Table
PT-HG08	8'	Heavy Gauge Steel Leg Table
PT-HG09HC	9'	Heavy Gauge Steel Leg Table (ADA Accessible)

Standard Model - 1 $\frac{1}{8}$ " O.D. legs or
Heavy-Duty Model- 2 $\frac{3}{8}$ " O.D. legs

STEEL LEGS



ADA Picnic Table with Steel Legs



Aluminum Picnic Table with Steel Legs

Model	Galvanized Steel Legs
PI	Portable Bench w/o Back
PD	Permanent Bench w/o Back
PE	Surface Mount Bench w/o Back
PB	Permanent Bench w/Back
PH	Surface Mount Bench w/Back
PG	Portable Bench w/Back



PI Portable Bench w/o Back

STEEL LEGS

"Our benches are up for the game."



PD Permanent Bench



PE Surface Mount Bench



PB Permanent Bench w/Back



PH Surface Mount Bench w/Back



PG Portable Bench w/Back



5-YEAR WARRANTY

Aluminum planks covered against blistering, cracking, peeling or flaking due to weather, temperature changes, continued exposure to rain, snow or U.V. rays from the sun.

1 Year Warranty - failure of structural strength of any framework component.

For full warranty information visit: bleachers.net



 **NRS**[™]
National Recreation Systems

A **PLAYCORE** Company

5120 Investment Drive, Fort Wayne, IN 46808

Toll Free **(888)-568-9064**

Fax **(260)-482-7449**

E-mail: sales@bleachers.net

Online: www.bleachers.net