

2016 PRODUCT CATALOG



ATHLETIC MFG. CO.
PATTERSON-WILLIAMS



COLOR OPTIONS

Standard Composite Plank Colors



Special Order Colors Add 5% to cost of product



PW Athletic uses PolyTuf™ extruded planks in our designs allowing us to extend a 20 year limited warranty. Manufactured in the U.S.A. from purified blends of post consumer, post industrial and virgin HDPE (high density polyethylene) base resins. With UV inhibited pigments, our recycled planks are made to withstand the elements.

200 Series Super Durable Powder Coat Colors



500 Series Super Durable Anti-Graffiti Powder Coat Colors



PW Athletic products are designed and built to stand up beautifully to the elements and daily public use.

Heavy Duty Steel, Premium quality Aluminum, and Super Durable Powder Coat Finish ensure that our products will be beautiful for years to come. All of our pieces represent an investment in quality, the best of the best.

Color chip samples are available, to order contact us at: 1(800) 687-5768 ext. 128

NEW FOR 2016!

**EXTRA HEAVY-DUTY RECYCLED
COMPOSITE ADA PICNIC TABLE**

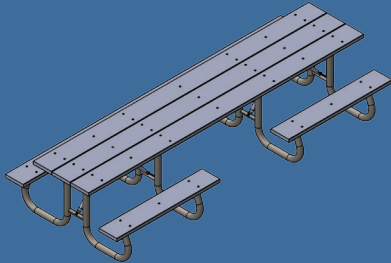

**Model #1121-12
Page 66**

**PERFORATED STEEL TOP
PICNIC TABLE**



**Model #4220-06P
Page 67**

**BRANDED RAINBOW
BIKE RACK**



Page 82

**PERSONALIZED
SITE FURNISHINGS**



Page 83

Catalog Quick View Index

Basketball Goal Systems.....	6-12
Basketball Backboards.....	13-15
Basketball Goals & Accessories.....	16-19
Volleyball Posts & Accessories.....	20-27
Tetherball.....	28
Tennis & Pickleball Posts.....	29-31
Soccer Goals.....	32-35
Soccer Nets & Accessories.....	36
Football Goals.....	37-38
Baseball Backstops.....	39-46
Dugouts.....	47
Baseball Accessories.....	48-49
Foul Ball Poles.....	50-51
Aluminum Seating.....	52-59
Park & Site Seating.....	60-70
Litter Receptacles.....	71-72
Recycling Center.....	73
Grills & Fire Rings.....	74
Bike Racks.....	75-80
Bollards.....	81
Customization.....	82-83

Known throughout the sports equipment industry as the leader in material quality, workmanship, and warranty, PW Athletic Mfg. Co. has been supplying schools, municipalities, and park districts throughout the U.S. and Canada since 1919.

We remain committed to purchasing materials made in the U.S. and continue to produce the most durable, long-lasting, customizable sports equipment being manufactured exclusively in America.

As we celebrate our 9th decade of manufacturing, P.W. Athletic Mfg. Co. remains totally committed to our mission...providing safe, functional and high-performing products across the board. We are equally committed to providing an excellent customer service experience to each and every one of our customers. We guarantee service that is always reliable, always resourceful, and always responsive.

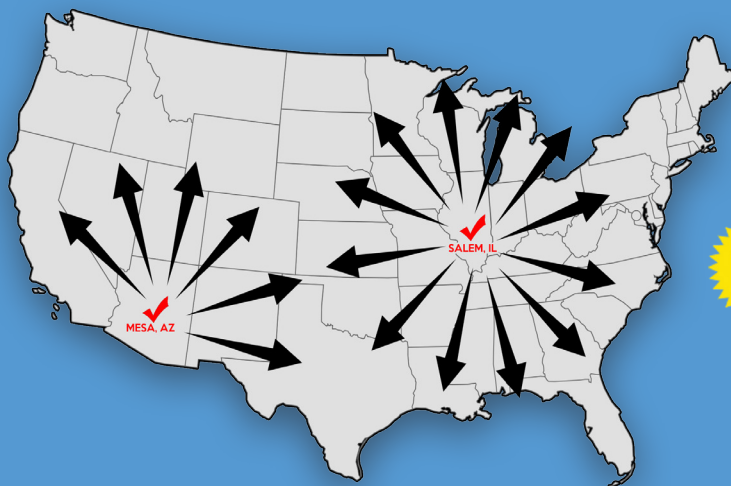
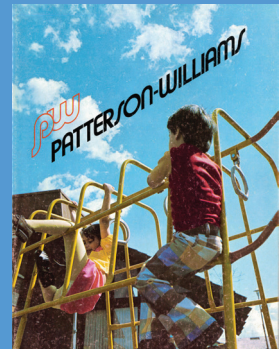
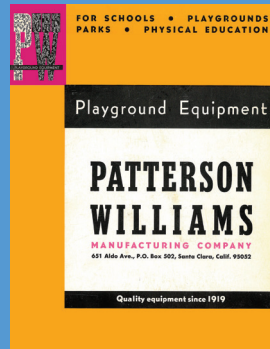
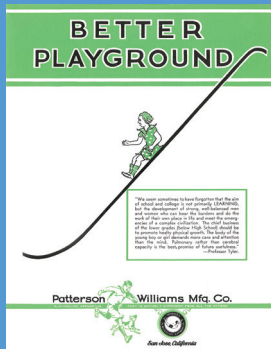

PW Quick Ship items will ship within 10 business days after receipt of order to our factory. Look for the Quick Ship throughout the catalog for "Quick Ship" items. Exception may be taken on large orders.

Facilities in the Southwest and Midwest help us keep freight charges to our clients as reasonable as possible and allow us to efficiently and quickly ship furnishings all across the country.

PW ATHLETIC IS A PROUD MEMBER OF THE FOLLOWING ORGANIZATIONS



PW Athletic...Quality manufacturing since 1919

PW Athletic Mfg. Co. warrants its products to be free from defect in materials or workmanship during normal use and installation provided our published specification installation instructions are followed and approved parts are used.

Warranty Terms

This warranty is valid only if the product has been subjected to normal use for the purpose for which it was designed; has not been subjected to vandalism, misuse, neglect, or accident; has not been subjected to addition or substitution of parts; and has not been modified or altered.

This warranty does not cover cosmetic items, for example; scratches, dents, marring, fading, discoloring, weathering, paint or decorations, normal wear and tear, or damage due to cracking and warping.

The warranty period begins on the date of invoice. It does not cover the cost of removal and/or installation warranted of the replaced product. All claims must be accompanied by a copy of the original invoice. PW Athletic must be notified before any corrective action is taken and reserves the right to determine whether claims will be fulfilled by replacement or by other means. Replacement parts are guaranteed for the remainder of the original warranty period.

LIFETIME LIMITED WARRANTY:

On all stationary basketball posts, all backboards and all basketball goals

20 YEAR LIMITED WARRANTY:

On all Recycled Composite Lumber

10 YEAR LIMITED WARRANTY:

On Bike Racks, Volleyball posts, Standard Tennis Posts, Soccer Goals, Foul Ball Poles, and Football Goalposts

3 YEAR LIMITED WARRANTY:

On all PW Products not listed, including all Hardware

1 YEAR LIMITED WARRANTY:

On all 1590 Model Adjustable Basketball posts, HD Tennis Posts, and all Nets and Protective Pads

Terms of Sale

Standard terms of payment are net 30-days from factory ship date for all publicly funded schools, park districts, municipalities and other publicly funded institutions. All others are 50% down, with balance required before shipment. A monthly finance charge of 1-1/2% per month will apply to all past due accounts. We accept Mastercard and Visa.

Please check your shipment carefully at time of delivery for possible damage or shortages. Although we take extra care to ensure your order is packed complete, items may become lost in transit. Check the Bill of Lading and Packing List at the time of delivery by the freight company for accuracy and/or possible shipping damage, and please call your local PW dealer immediately to assist with any questions or subsequent freight claims.

During the year, our engineering team finds new ways to improve our product designs. Rather than make our customers wait until year's end and a new catalog to make these improvements, we do reserve the right to change product specifications without notice.

Orders for custom or modified equipment require 50% down and cannot be cancelled. Returns on any product will need to be authorized by PW and assigned an RGA number prior to shipment. A 20% restocking charge will apply on returned goods. Any questions concerning our terms or warranties can be directed to your local PW dealer or by contacting the PW customer service department at 1-800-687-5768.

BASKETBALL GOAL SYSTEMS

1 Pick a Post + **2** Pick a Backboard + **3** Pick a Goal with Net = Complete Unit

SINGLE GOOSENECK POSTS

Our Single Gooseneck Basketball Posts feature several different outer diameter galvanized steel pipes ranging from 3-1/2" up to 6-5/8" that are engineered to a 4, 5 or 6 foot offset. Posts come galvanized as standard, however we do have Powder Coating options available on page 2.



Model #1516-13-45

- Heavy-duty 4-1/2" O.D. Galvanized steel post with 4' offset (braces not included), Model #1516.
- Solid 1/4" steel backboard, Model #13.
- Heavy-duty double rim goal & Super-Nylon net, Model #45.

COMPLETE PACKAGE

\$841.00 (Galvanized finish)

NOTE: 1521 Post will only accommodate #18, #22, #23 and #30 backboards. Nets not covered under warranty. See page 18, for Post Pads & Ground Sleeves.

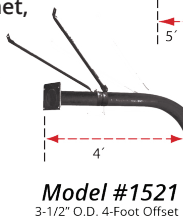

Model #1521
3-1/2" O.D. 4-Foot Offset

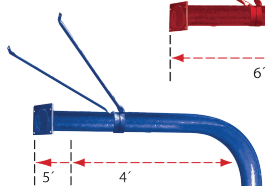

Model #1523
4-1/2" O.D. 4-Foot Offset



Model #1520
4-1/2" O.D. 5-Foot Offset



Model #1516
4-1/2" O.D. 4-Foot Offset (No Bracing)

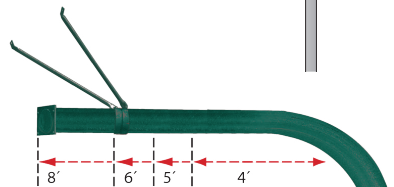

Model #1525
4-1/2" O.D. 6-Foot Offset



Model #1540
5-9/16" O.D. 4-Foot Offset



Model #1541
5-9/16" O.D. 5-Foot Offset



Model #1527
5-9/16" O.D. 6-Foot Offset



Model #1560
6-5/8" O.D. 6-Foot Offset

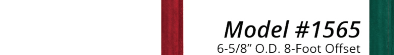

Model #1565
6-5/8" O.D. 8-Foot Offset

Single Gooseneck Posts

Model	Description	Weight	Powder Coat Price	Galvanized Price
1516	4-1/2" O.D., 4' offset (no bracing)	178 lbs.	\$660	\$393
1521	3-1/2" O.D., 4' offset	135 lbs.	\$692	\$422
1523	4-1/2" O.D., 4' offset	185 lbs.	\$721	\$448
1520	4-1/2" O.D., 5' offset	195 lbs.	\$746	\$471
1525	4-1/2" O.D., 6' offset	210 lbs.	\$798	\$492
1540	5-9/16" O.D., 4' offset	260 lbs.	\$1,034	\$734
1541	5-9/16" O.D., 5' offset	275 lbs.	\$1,057	\$755
1527	5-9/16" O.D., 6' offset	290 lbs.	\$1,126	\$765
1560	6-5/8" O.D., 6' offset	376 lbs.	\$1,434	\$1,047
1565	6-5/8" O.D., 8' offset	425 lbs.	\$1,659	\$1,344



BASKETBALL

BASKETBALL GOAL SYSTEMS

1 Pick a Post + **2** Pick 2 Backboards + **3** Pick 2 Goals w/Nets = Complete Unit

BACK-TO-BACK GOOSENECK POSTS

Our Back-To-Back Gooseneck Basketball Posts feature several different outer diameter galvanized steel pipes ranging from 3-1/2" up to 6-5/8", these posts are secured together above and below grade to form two offsets for back-to-back courts. Powder Coating options available on page 2.



Model #1522-18(2)-45(2)

- Double 3-1/2" O.D. Heavy-duty galvanized steel post set with 4' offsets and diagonal support braces, Model #1522 (1).
- 1-1/2" Fiberglass Fan Backboards, heavy double-wall construction, Model #18 (2).
- Heavy-duty double rim goals w/Super-Nylon net*, Model #45 (2).

COMPLETE PACKAGE

\$2475.00 (Galvanized finish)



NOTE: 1522 Post will only accommodate #18, #22, #23 and #30 backboards. Nets not in warranty. Quick Ship Items in Galvanized Only.



Back-To-Back Gooseneck Posts

Model	Description	Weight	Powder Coat Price	Galvanized Price
1514	4-1/2" O.D., 4' offset (no bracing)	370 lbs.	\$1,299	\$879
1522	3-1/2" O.D., 4' offset	275 lbs.	\$1,283	\$863
1524	4-1/2" O.D., 4' offset	380 lbs.	\$1,383	\$963
1542	4-1/2" O.D., 5' offset	392 lbs.	\$1,467	\$994
1526	4-1/2" O.D., 6' offset	420 lbs.	\$1,490	\$1,017
1543	5-9/16" O.D., 4' offset	520 lbs.	\$1,889	\$1,469
1544	5-9/16" O.D., 5' offset	550 lbs.	\$1,989	\$1,516
1528	5-9/16" O.D., 6' offset	580 lbs.	\$2,015	\$1,689
1561	6-5/8" O.D., 6' offset	752 lbs.	\$2,569	\$2,297

BASKETBALL GOAL SYSTEMS

1 Pick a Post + **2** Pick a Backboard + **3** Pick a Goal with Net = Complete Unit

SINGLE POST (w/Adjustable Offsets)

A single post, manufactured of either 4-1/2" O.D., 5-9/16" O.D. or 6-5/8" O.D. heavy-duty, galvanized steel pipe. Height adjustment permits regulation play for use by children, as well as physically challenged individuals. Adjustable offsets are manufactured of 2-3/8" O.D. pipe, welded to 1/4" thick galvanized steel half clamps. 1-5/16" O.D. braces support the upper portion of the backboard for stability during play. Powder Coating options available on page 2.

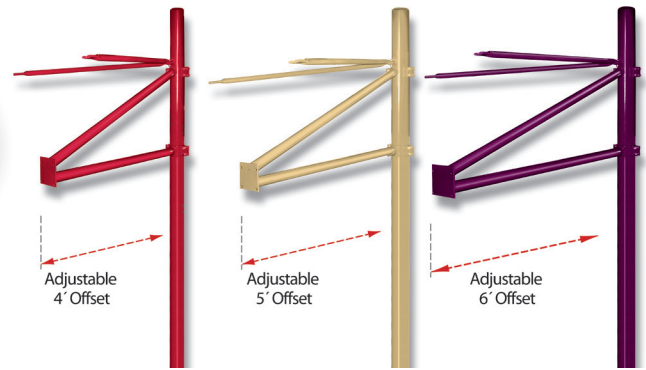

Model #1531-13-31

- Heavy-duty 4-1/2" O.D. Galvanized steel post with 4' offset and diagonal support braces.
- Solid 1/4" heavy-duty steel fan backboard, Powder Coated white.
- Extra Heavy-duty double rim goal with standard chain net
- Shown Powder Coated.

COMPLETE PACKAGE

\$1,274.00 (Powder Coat finish)



Single Post (w/Adjustable Offsets)

Model	Description	Weight	Powder Coat Price	Galvanized Price
1531	4-1/2" O.D., 4' offset	240 lbs.	\$823	\$642
1529	4-1/2" O.D., 5' offset	251 lbs.	\$834	\$653
1530	4-1/2" O.D., 6' offset	262 lbs.	\$870	\$664
1533	5-9/16" O.D., 4' offset	305 lbs.	\$939	\$702
1537	5-9/16" O.D., 5' offset	310 lbs.	\$970	\$734
1535	5-9/16" O.D., 6' offset	325 lbs.	\$1,002	\$765
1563	6-5/8" O.D., 6' offset	422 lbs.	\$1,285	\$1,049

1 Pick a Post + **2** Pick 2 Backboards + **3** Pick 2 Goals w/Nets = Complete Unit

BACK-TO-BACK SINGLE POST (w/Adjustable Offsets)

Used for back-to-back courts. This version features the same rugged construction as our single offset adjustable posts. Select a matching single-offset for opposite ends of the court. Powder Coating options available on page 2.



Model #1536-13(2)-45(2)

- (1) Massive 5-9/16" O.D. post made of heavy-duty galvanized steel pipe with 2-3/8" O.D. dual adjustable 6' offsets and diagonal braces.
- (2) Heavy-duty solid steel fan backboards
- (2) Extra heavy-duty double rim goals with Super-Nylon net.
- Shown Powder Coated.

COMPLETE PACKAGE

\$2,217.00 (Powder Coat finish)



Back-To-Back Single Posts

Model	Description	Weight	Powder Coat Price	Galvanized Price
1532	4-1/2" O.D., 4' offset	285 lbs.	\$1,049	\$734
1547	4-1/2" O.D., 5' offset	290 lbs.	\$1,070	\$755
1545	4-1/2" O.D., 6' offset	295 lbs.	\$1,091	\$776
1534	5-9/16" O.D., 4' offset	350 lbs.	\$1,231	\$956
1546	5-9/16" O.D., 5' offset	360 lbs.	\$1,271	\$996
1536	5-9/16" O.D., 6' offset	410 lbs.	\$1,321	\$1,046
1562	6-5/8" O.D., 6' offset	532 lbs.	\$1,514	\$1,264

BASKETBALL GOAL SYSTEMS

1 Pick a Post + **2** Pick a Backboard + **3** Pick a Goal with Net = Complete Unit

DUAL POSTS

3-1/2" O.D. posts form this upright and are connected with a pair of 3/16" galvanized steel collars. With the diagonal braces included, the backboards are supported from both top and bottom. Choose from any of our backboard styles. Powder Coating options available on page 2.

Perfect for Institutional Use!

DUAL POSTS, SEPARATED

Dual post construction of Heavy-Duty galvanized steel featuring a unique design providing strength, durability, and rigidity not found in conventional uprights. Choose from any of our backboard styles. Powder Coating options available on page 2.



Model #1511-26-45

- Extra Heavy-duty dual 3-1/2" O.D. Galvanized steel posts with 4' offset and Diagonal Support Braces.
- Heavy-duty rectangular steel Powder Coated backboard.
- Heavy-duty double rim goal with Super-Nylon net.

COMPLETE PACKAGE

\$1,876.00 (Galvanized finish)

Model #1554-24T-45

- Extra Heavy-duty dual 4-1/2" O.D. Galvanized steel posts with 4' offset.
- 1" Heavy-duty solid white Polyethylene Rectangle board with solid Poly Target.
- Heavy-duty double rim goal with Super-Nylon net.

COMPLETE PACKAGE

\$2,334.00 (Galvanized finish)



Dual Posts

Model	Description	Weight	Powder Coat Price	Galvanized Price
1511	3-1/2" O.D. Dual Post, 4' offset	280 lbs.	\$1,415	\$1,160
1513	3-1/2" O.D. Dual Post, 6' offset	305 lbs.	\$1,445	\$1,185

Dual Post, Separated

Model	Description	Weight	Powder Coat Price	Galvanized Price
1554	4-1/2" O.D. Dual Post, Separated, 4' offset	280 lbs.	\$1,578	\$1,145
1555	5-9/16" O.D. Dual Post, Separated, 6' offset	305 lbs.	\$1,891	\$1,493

1 Pick a Post + **2** Pick a Backboard + **3** Pick a Goal with Net = Complete Unit

TRUSS POST GOOSENECK

Manufactured of galvanized steel, this Heavy-Duty Post comes in 3-1/2" O.D. and 4-1/2" O.D. with 4', 5' and 6' offsets. A 2-3/8" O.D. welded support post makes this post even more rugged and stable. Powder Coating options available on page 2.

Our Strongest Post Option!

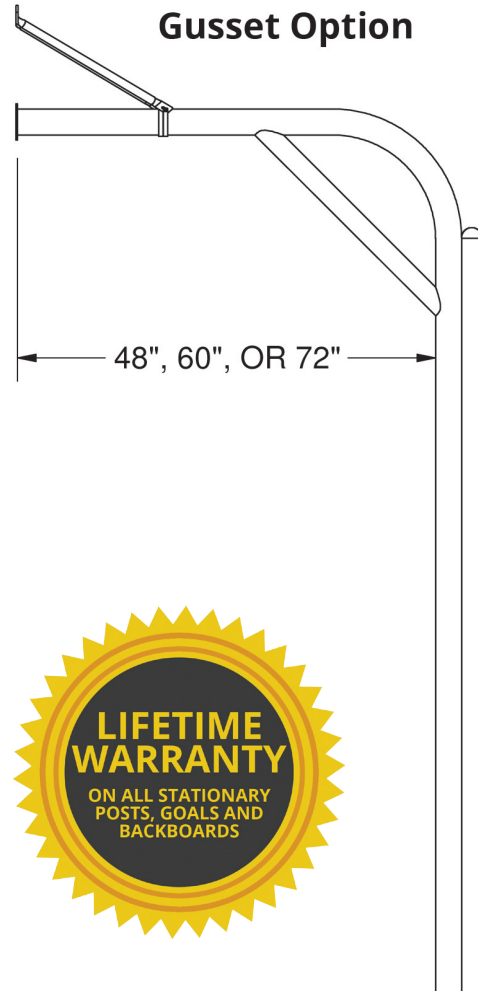

Model #1571-22-45

- Heavy-duty 4-1/2" O.D. Galvanized steel post with 4' offset, diagonal bracing and welded 2-3/8" O.D. steel post support
- Heavy-duty Cast Aluminum Fan Backboard
- Heavy-duty double rim goal with Super-Nylon net.

COMPLETE PACKAGE

\$1,254.00 (Galvanized finish)



Truss Post Gooseneck

Model	Description	Weight	Powder Coat Price	Galvanized Price
1569	4-1/2" O.D., 4' offset (no bracing)	181 lbs.	\$848	\$611
1570	3-1/2" O.D., 4' offset	159 lbs.	\$734	\$492
1571	4-1/2" O.D., 4' offset	188 lbs.	\$891	\$639
1572	4-1/2" O.D., 5' offset	199 lbs.	\$912	\$723
1573	4-1/2" O.D., 6' offset	210 lbs.	\$986	\$755
1583	4-1/2" O.D., 4' offset(w/gusset)	208 lbs.	\$1,048	\$809
1584	4-1/2" O.D., 5' offset(w/gusset)	219 lbs.	\$1,062	\$824
1585	4-1/2" O.D., 6' offset(w/gusset)	230 lbs.	\$1,086	\$855

BASKETBALL GOAL SYSTEMS

6" SQUARE POST/ ADJUSTABLE

Manufactured of 6" square steel, this post offers two lengths of offsets and diagonal braces. With PW's exclusive design, you can put any backboard on this post. Available standard as powder coated. This post is also available as hot-dipped galvanized. Powder coat colors on page 2.

**Hot Dipped Galvanized
Recommended for
Coastal Spray Areas!**



Model #1590

- Heavy-duty 6" square powder coated steel post
- Height adjusts from 7-1/2' to 10'.
- 42" x 72" x 3/8" thick clean acrylic backboard welded to a heavy-duty steel frame
- Includes heavy-duty break away goal, nylon net, black post pad and backboard padding.
- Uses a J-blot anchoring system.
- Available in black.

Model #1577-13-45-29-8379

- Heavy-duty 6" square steel post with 5' offset and diagonal bracing
- 1/4" Heavy-duty solid steel fan, Powder Coated White
- Post Pad for 6" square post
- Shown with optional target and perimeter

COMPLETE PACKAGE

\$2,261.00 (Powder Coated finish)

6" Square Post/Adjustable

Model	Description	Weight	Powder Coat Price	Hot Dip Galv
1576	6" Sq Post, 4' offset	305 lbs.	\$1,028	\$1,338
1577	6" Sq Post, 5' offset	325 lbs.	\$1,149	\$1,361
1578	6" Sq Post, Back to Back, 4' offset	425 lbs.	\$1,439	\$1,636
1579	6" Sq Post, Back to Back, 5' offset	435 lbs.	\$1,499	\$1,894

6" Square Post/Adjustable w/Acrylic Backboard System

Model	Description	Weight	Powder Coat Price
1590	6" Adjustable Basketball System	450 lbs.	\$2,833

1 Pick a Post + **2** Pick a Backboard + **3** Pick a Goal with Net = Complete Unit

BACKBOARDS

Manufactured of aluminum, steel, fiberglass, polyethylene, or polycarbonate, built to withstand the toughest play. With PW Athletics six hole mounting system there is no more trying to align mounting plates, backboards and goal holes all at one time. Our system allows you to attach the backboard to the mounting plate which free up your hands for the goal installation.

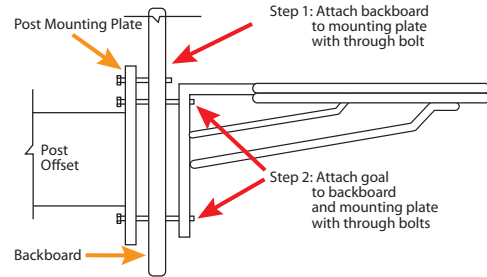

Front Views

Back Views



Model #27
Lifetime Warranty

Description	Weight	Price
Polycarbonate with Aluminum Frame and White Target	135 lbs.	\$1,953



Model #24T
Lifetime Warranty

Description	Weight	Price
1" Heavy-duty Solid White Polyethylene Rectangle with solid Poly Target	160 lbs.	\$1,054



Model #24
Lifetime Warranty

Description	Weight	Price
1" Heavy-duty Solid White Polyethylene Rectangle	160 lbs.	\$949

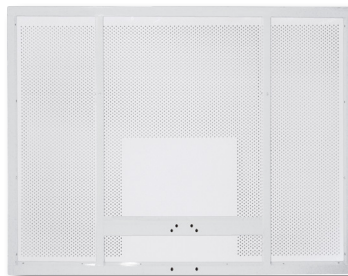
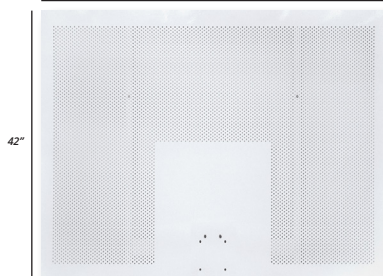

Model #10
Lifetime Warranty

Description	Weight	Price
Heavy-duty Perforated Steel, Powder Coated White	180 lbs.	\$838

BASKETBALL

BASKETBALL BACKBOARDS



Front Views

Back Views

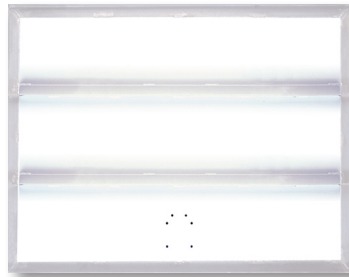
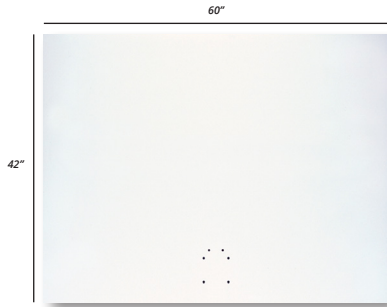

Model #19
Lifetime Warranty

Description	Weight	Price
Heavy-duty all Aluminum Rectangle Powder Coated White	145 lbs.	\$849

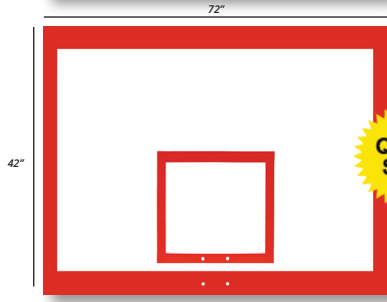

Model #20
Lifetime Warranty

Description	Weight	Price
1-1/2" Fiberglass Rectangle White with Target and Perimeter	103 lbs.	\$988

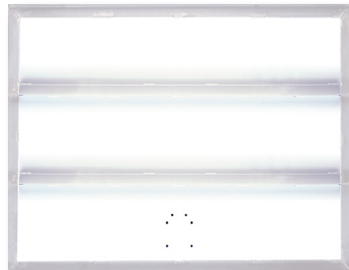

Model #25
Lifetime Warranty

Description	Weight	Price
12-Gauge Steel Rectangle Powder Coated White	170 lbs.	\$786

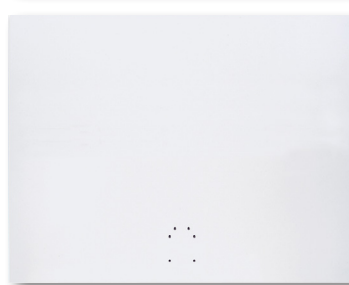

Model #26
Lifetime Warranty

Description	Weight	Price
1/4" Heavy-duty Solid Steel Rectangle Powder Coated White	180 lbs.	\$581



Backboard Targets & Perimeters

Model	Description	Weight	Price
28	Backboard Target for Model #10,13,14,18,19,20,22,25,26	N/A	\$58
29	Backboard Target & Perimeter for Model #10,13,14,18,19,20,22,25,26	N/A	\$104



BASKETBALL BACKBOARDS

Front Views

Back Views



Model #22
Lifetime Warranty

Description	Weight	Price
Heavy-duty Cast Aluminum, Powder Coated White	61 lbs.	\$480



Model #14
Lifetime Warranty

Description	Weight	Price
1/4" Heavy-duty Solid Steel Fan, Hot-Dip Galvanized	125 lbs.	\$419

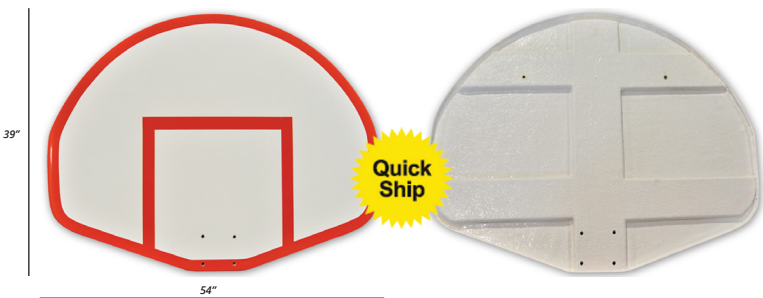

Model #18
Lifetime Warranty

Description	Weight	Price
1-1/2" Fiberglass White Fan with Target and Perimeter	49 lbs.	\$671

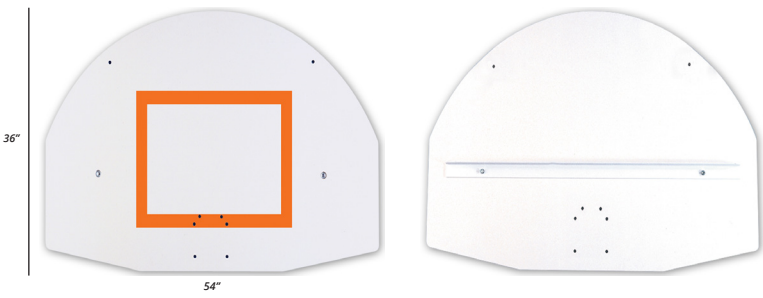

Model #30
Lifetime Warranty

Description	Weight	Price
Heavy-duty 1" Solid White Polyethylene Fan with Solid Poly Target	71 lbs.	\$747



Model #13
Lifetime Warranty

Description	Weight	Price
1/4" Heavy-duty Solid Steel Fan, Powder Coated White	116 lbs.	\$313



Model #23
Lifetime Warranty

Description	Weight	Price
Heavy-duty 1" Solid White Polyethylene Fan	70 lbs.	\$608

BASKETBALL GOALS

GOALS & NETS

Have you had trouble finding a goal that will retrofit to your existing backboard? The PW "Easy Mount" back plate, standard on all of our eight rim styles, is engineered to accommodate a wide variety of hole patterns. We promise you that our rims will fit on almost every front-mount backboard out there today! And you can select a nylon, chain, or vinyl net that's suitable for your court's use and environment.

Heavy-Duty Double Rim and Net Combinations



Model #31



Model #44



Model #45

Extra Heavy-Duty Double Rim and Net Combinations



Model #37



Model #38



Model #39

Basketball Goals

Model	Description	Weight	Price
45	Heavy-Duty Double Rim w/Universal Mount Plate & Super Nylon Net	15 lbs.	\$135
31	Heavy-Duty Double Rim w/Universal Mount Plate & Chain Net	15 lbs.	\$138
44	Heavy-Duty Double Rim w/Universal Mount Plate & Super Chain Net	18 lbs.	\$179
39	Extra Heavy-Duty Double Rim w/Universal Mount Plate & Super Nylon Net	25 lbs.	\$219
38	Extra Heavy-Duty Double Rim w/Universal Mount Plate & Chain Net	26 lbs.	\$227
37	Extra Heavy-Duty Double Rim w/Universal Mount Plate & Super Chain Net	28 lbs.	\$270
41-Flex	Breakaway Extra Heavy-Duty Double Rim w/Universal Mount Plate & Super Nylon Net	29 lbs.	\$237



UNIVERSAL MOUNT PLATE ON ALL OUR GOALS!

Trouble finding the goal to fit your exact size requirements? The PW "Easy-Mount" back plate is engineered to accommodate a variety of hole patterns, guaranteeing you that it will fit on most front-mount backboards!

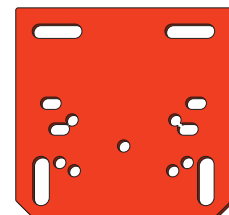

1 Pick a Post + **2** Pick a Backboard + **3** Pick a Goal with Net = Complete Unit



Replacement Nets

Breakaway Double Rims



Model #41-FLEX



Model #33



Model #34







Model #35



Model #36

Replacement Nets

Model	Description	Weight	Price
 33	Chain Net	1 lb.	\$19
 34	Super Nylon Net	1 lb.	\$14
 35	Super Chain Net	3 lbs.	\$62
 36	Vinyl Cable Net	3 lbs.	\$39

UNIVERSAL MOUNT PLATE ON ALL OUR GOALS!

Trouble finding the goal to fit your exact size requirements?
The PW "Easy-Mount" back plate is engineered to accommodate a variety of hole patterns, guaranteeing you that it will fit on most front-mount backboards!

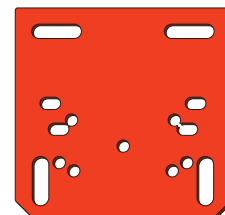

BASKETBALL ACCESSORIES

POST PADS & GROUND SLEEVES

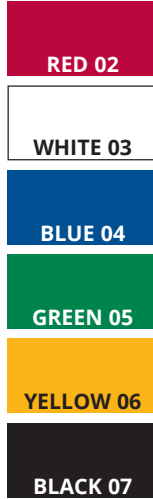

Post Pads are available for installation around posts providing an extra measure of safety for active players. The pads are constructed utilizing 18 ounce coated vinyl, which covers a 4" thick, high density, urethane foam.

Pads feature hook and loop fasteners and are available in 6 standard colors: Red (02), White (03), Blue (04), Green (05), Yellow (06), and Black (07). Please specify your color choice when ordering. All pads are 6-feet high and cover post applications from 3-1/2" O.D. to 6-5/8" O.D. Standard 8" high lettering is available (maximum of 8 letters per pad) at a price addition of \$150.00 per post pad.

Basketball Post Ground Sleeves are inserts for concrete footings used to hold basketball posts firmly in place and to allow removal of post. Optional caps are available to keep dirt and debris out when posts are not in place. The sleeves listed below are steel and treated for rust corrosion.



Post Pads

Model	Description	Weight	Price
8376-03	Post Pad for round posts up to 3-1/2"OD	10 lbs.	\$460
8376-04	Post Pad for round posts up to 4-1/2"OD	12 lbs.	\$464
8376-05	Post Pad for round posts up to 5-9/16"OD	15 lbs.	\$520
8376-06	Post Pad for round posts up to 6-5/8"OD	30 lbs.	\$799
8377-00	Post Pad - Custom Made to Fit	N/A	Call for Pricing
8379-06	Post Pad for square posts 5" to 6"	20 lbs.	\$560

Basketball Post Ground Sleeves

Model	Description	Weight	Price
8303-36-1	Sleeve for 3-1/2" O.D. 36" Depth Post (w/o cap)	30 lbs.	\$127
8303-36-1N	Sleeve for 3-1/2" O.D. 36" Depth Post (w/neoprene cap)	32 lbs.	\$197
8304-36-1	Sleeve for 4-1/2" O.D. 36" Depth Post (w/o cap)	40 lbs.	\$245
8304-36-1N	Sleeve for 4-1/2" O.D. 36" Depth Post (w/neoprene cap)	42 lbs.	\$323
8305-48-1	Sleeve for 5-9/16" O.D. 48" Depth Post (w/o cap)	50 lbs.	\$265
8305-48-1N	Sleeve for 5-9/16" O.D. 48" Depth Post (w/neoprene cap)	52 lbs.	\$348
8306-48-1	Sleeve for 6-5/8" O.D. 48" Depth Post (w/o cap)	76 lbs.	\$524
8306-48-1N	Sleeve for 6-5/8" O.D. 48" Depth Post (w/neoprene cap)	77 lbs.	\$614

ADJUSTABLE OFFSETS

Have an existing post that needs bracing? These diagonal support braces can be used on any existing 3-1/2" O.D., 4-1/2" O.D., 5-9/16" O.D., and 6-5/8" O.D. straight post without bracing. Adjustable Offsets are manufactured of 2-3/8" O.D. Galvanized steel with diagonal braces of 1-3/8" O.D. Galvanized steel, factory welded to our standard mounting plate. Powder coat colors on page 2.

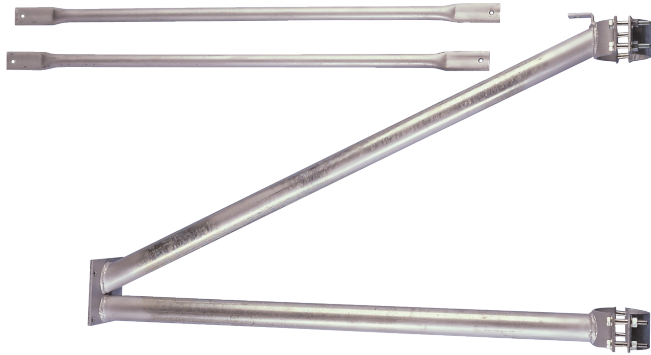

Model #8101-10
\$305 Galvanized

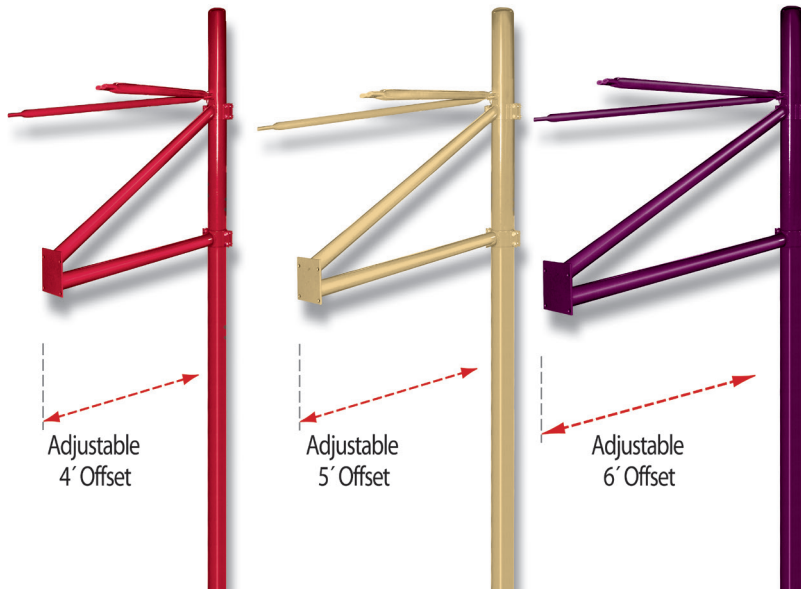

Adjustable Offsets

Model	Description	Weight	Powder Coat Price	Galvanized Price
8103-10	4' Offset for 3-1/2" O.D. Post (w/hardware)	50 lbs.	\$388	\$276
8101-10	4' Offset for 4-1/2" O.D. Post (w/hardware)	53 lbs.	\$415	\$305
8101-05	5' Offset for 4-1/2" O.D. Post (w/hardware)	56 lbs.	\$423	\$311
8101-15	6' Offset for 4-1/2" O.D. Post (w/hardware)	58 lbs.	\$431	\$320
8102-10	4' Offset for 5-9/16" O.D. Post (w/hardware)	54 lbs.	\$475	\$363
8102-15	5' Offset for 5-9/16" O.D. Post (w/hardware)	59 lbs.	\$491	\$378
8104-10	6' Offset for 5-9/16" O.D. Post (w/hardware)	68 lbs.	\$504	\$394
8104-15	6' Offset for 6-5/8" O.D. Post (w/hardware)	75 lbs.	\$580	\$468

VOLLEYBALL POSTS



Model #2216-00 \$479 pr. Galvanized

COMPETITION POSTS with FIXED EYES & ROPE CLAMPS

Each competition post comes with individual components. Post 1 has 2 fixed eyes. Post 2 has 2 fixed eyes with rope clamps. All posts are provided in pairs and come standard as galvanized. 3-1/2" O.D. and 4-1/2" O.D. Aluminum posts are also available. These competition posts are specifically for use with nets equipped with top rope (8362-10 or 8362-20) see page 25. Powder coat colors on page 2.

Quick
Ship

Competition Post Sets with Fixed Eyes & Rope Clamps

Model	Description	Weight	Powder Coat Price	Galvanized Price
2214-00	2-7/8" O.D. Galv. Competition Volleyball Post Set	125 lbs.	\$490 pr.	\$285 pr.
2216-00	3-1/2" O.D. Galv. Competition Volleyball Post Set	157 lbs.	\$629 pr.	\$479 pr.
2217-00	4-1/2" O.D. Galv. Competition Volleyball Post Set	227 lbs.	\$669 pr.	\$519 pr.
2218-00	5-9/16" O.D. Galv. Competition Volleyball Post Set	307 lbs.	\$977 pr.	\$827 pr.
2216-00A	3-1/2" O.D. Aluminum Competition Volleyball Post Set	144 lbs.	\$747 pr.	\$597 pr.
2217-00A	4-1/2" O.D. Aluminum Competition Volleyball Post Set	206 lbs.	\$936 pr.	\$786 pr.
	Factory Drilled Holes for Misting System	N/A	\$50	\$50

All of our posts found on pages 18-20 are designed to be 8'6" above the playing surface. When ordering posts for your sand volleyball court an additional length of post will be added to accommodate the depth of the sand. See page 27 for pricing. Please specify additional length at time of order.

Quick Ship items are available for Galvanized posts only.

10 YEAR
LIMITED
WARRANTY



Model #2216-31 \$261 Galvanized

COMPETITION SINGLE CENTER POST

with FIXED EYES & ROPE CLAMPS

Center posts come equipped with 2 fixed eyes with rope clamps. This single center post is designed for use on side-by-side courts and is compatible to its mating competition posts. Posts come galvanized as standard. Optional 3-1/2" O.D. and 4-1/2" O.D. Aluminum posts are also available. These center posts are specifically for use with nets equipped with top rope (8362-10 or 8362-20) see page 25. Powder coat colors on page 2.



When ordering posts for your sand volleyball court an additional length of post will be added to accommodate the depth of the sand. See page 25 for pricing. Please specify additional length at time of order.



Competition Single Center Post w/Fixed Eyes & Rope Clamps



Model	Description	Weight	Powder Coat Price	Galvanized Price
2214-31	2-7/8" O.D. Galvanized Center Post	63 lbs.	\$275	\$200
2216-31	3-1/2" O.D. Galvanized Center Post	80 lbs.	\$336	\$261
2217-31	4-1/2" O.D. Galvanized Center Post	115 lbs.	\$420	\$345
2218-31	5-9/16" O.D. Galvanized Center Post	155 lbs.	\$588	\$513
2216-31A	3-1/2" O.D. Aluminum Center Post	50 lbs.	\$483	\$408
2217-31A	4-1/2" O.D. Aluminum Center Post	85 lbs.	\$567	\$492
	Factory drilled holes for misting system.	N/A	\$50	\$50

Quick Ship items are available for Galvanized posts only.

VOLLEYBALL POSTS



DELUXE COMPETITION POSTS

with NET TIGHTENER, SIDE PULLEY & ROPE CLAMPS

Each competition post comes equipped with individual components. Post 1 has 2 fixed eyes. Post 2 has standard net tightener with Removable Handle, side pulley, 1 fixed eye with rope clamp. All posts are provided in pairs and come galvanized as standard. Optional 3-1/2" O.D. and 4-1/2" O.D. Aluminum posts are available. These competition posts can be used with net models equipped with top cables (models 8361-10 and 8361-20) or top rope (8362-10 or 8362-20) see page 25. Powder coat colors on page 2.

When ordering posts for your sand volleyball court an additional length of post will be added to accommodate the depth of the sand. See page 25 for pricing. Please specify additional length at time of order.



Model #2216-21P
\$800 Powder Coated



Deluxe Competition Post Sets w/Net Tightener, Side Pulley & Rope Clamp



Model	Description	Weight	Powder Coat Price	Galvanized Price
2214-21	2-7/8" O.D. Galvanized Post	135 lbs.	\$673 pr.	\$473 pr.
2216-21	3-1/2" O.D. Galvanized Post	168 lbs.	\$800 pr.	\$600 pr.
2217-21	4-1/2" O.D. Galvanized Post	238 lbs.	\$937 pr.	\$734 pr.
2218-21	5-9/16" O.D. Galvanized Post	318 lbs.	\$969 pr.	\$769 pr.
2216-21A	3-1/2" O.D. Aluminum Post	146 lbs.	\$878 pr.	\$678 pr.
2217-21A	4-1/2" O.D. Aluminum Post	208 lbs.	\$941 pr.	\$741 pr.
	Factory drilled holes for misting system.	N/A	\$50	\$50

Quick Ship items are available for Galvanized posts only.



Model #2216-41 \$406 Galvanized



DELUXE COMPETITION SINGLE CENTER POST

with NET TIGHTENER, SIDE PULLEY & ROPE CLAMPS

Center post comes equipped with 2 fixed eyes, rope clamp, standard net tightener with removable handle and side pulley as shown above. This single center post is designed for use when a side-by-side court layout is required, and is ordered in addition to compatible mating competition post models 2214, 2216, 2217, and 2218. Posts come galvanized as standard. 3-1/2" O.D. and 4-1/2" O.D. Aluminum posts are also available. These center posts can be used with net models . 3-1/2" O.D. and 4-1/2" O.D. Aluminum posts are also available. These center posts can be used with net models equipped with top cables (models 8361-10 and 8361-20) or top rope (8362-10 or 8362-20) see page 25. Powder coat colors on page 2.

When ordering posts for your sand volleyball court an additional length of post will be added to accommodate the depth of the sand. See page 25 for pricing. Please specify additional length at time of order.



Deluxe Competition Single Center Post w/Fixed Eyes & Rope Clamp

Model	Description	Weight	Powder Coat Price	Galvanized Price
2214-41	2-7/8" O.D. Galvanized Center Post	75 lbs.	\$431	\$356
2216-41	3-1/2" O.D. Galvanized Center Post	93 lbs.	\$481	\$406
2217-41	4-1/2" O.D. Galvanized Center Post	170 lbs.	\$553	\$478
2218-41	5-9/16" O.D. Galvanized Center Post	250 lbs.	\$698	\$623
2216-41A	3-1/2" O.D. Aluminum Center Post	63 lbs.	\$579	\$504
2217-41A	4-1/2" O.D. Aluminum Center Post	148 lbs.	\$611	\$536
	Factory drilled holes for misting system.	N/A	\$50	\$50

Quick Ship items are available for Galvanized posts only.



PRO SERIES COMPETITION POSTS

with NET TIGHTENER, SIDE PULLEY & ROPE CLAMPS

Each competition post comes equipped with individual components. Post 1 has 2-fixed eyes. Post 2 has standard net tightener with removable handle, side pulley, 1 fixed eye with rope clamp. All posts are provided in pairs. These competition posts can be used with net models equipped with top cables (models 8361-10 and 8361-20) or top rope (8362-10 or 8362-20). Powder coat colors available on page 2.

Model #2219-21P
\$849 Powder Coated



Pro Series Competition Post Sets

Model	Description	Weight	Powder Coat Price	Galvanized Price
2219-20A	Powder Coated 4" Square Aluminum Posts	145 lbs.	\$681 pr.	N/A
2219-20P	Powder Coated 4" Square Steel Posts	145 lbs.	\$779 pr.	N/A
2219-20HDG	Hot-Dipped Galvanized 4" Square Steel Posts	145 lbs.	N/A	\$1,049 pr.
2219-21A	Powder Coated 5" Square Aluminum Posts	175 lbs.	\$879 pr.	N/A
2219-21P	Powder Coated 5" Square Steel Posts	175 lbs.	\$849 pr.	N/A
2219-21HDG	Hot-Dipped Galvanized 5" Square Steel Posts	175 lbs.	N/A	\$1,254 pr.

COMPETITION VOLLEYBALL NETS

PW offers volleyball nets that are compatible with all our volleyball posts. These nets are designed with 3mm nylon mesh in a 5" x 7" size. The headband manufactured of 2" white PVC tarp, and side and bottom bindings made of 1" white PVC tarp. Model 8361 features top steel cable and rope ties on bottom. Model 8362 features rope top and bottom.



Top Rope Model #8362-10
\$124



Top Cable Model #8361-10
\$129



Competition Volleyball Nets

Model	Description	Net Size	Weight	Price
8361-10	Top Cable/Bottom Rope Ties	30' x 3'	6 lbs.	\$129
8361-20	Top Cable/Bottom Rope Ties	32' x 3'	7 lbs.	\$135
8362-10	Top Rope/Bottom Rope Ties	30' x 3'	5 lbs.	\$124
8362-20	Top Rope/Bottom Rope Ties	32' x 3'	6 lbs.	\$130

VOLLEYBALL BOUNDARY MARKERS

All markers featured below open up into a 30' x 60' court size shape for marking sand volleyball court boundaries.



Model #8365



Model #8371



Model #8370



Model #8372



Model #8369

Volleyball Boundary Markers

Model	Description	Weight	Price
8364	1" Strap (with 4 Anchors)	4 lbs.	\$135
8365	2" Strap (with 4 Anchors)	8 lbs.	\$189
8369	1-1/4" Rope (with #8372 Stakes)	75 lbs.	\$620
8370	3/4" Rope (with #8372 Stakes)	18 lbs.	\$286
8371	1/4" Rope (with 4 Anchors)	3 lbs.	\$98
8372	Heavy-Duty Steel Stakes (with 4 Anchors)	13 lbs.	\$92



VOLLEYBALL MISTING SYSTEM

Keep your court cool on those hot summer days with our Volleyball Court Misting System. This system comes with everything you will need to beat the heat. Note* Misting System only available for Aluminum Post Systems.

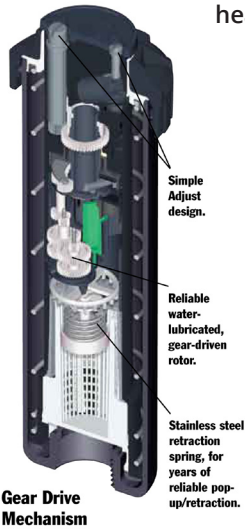

Full Court Coverage

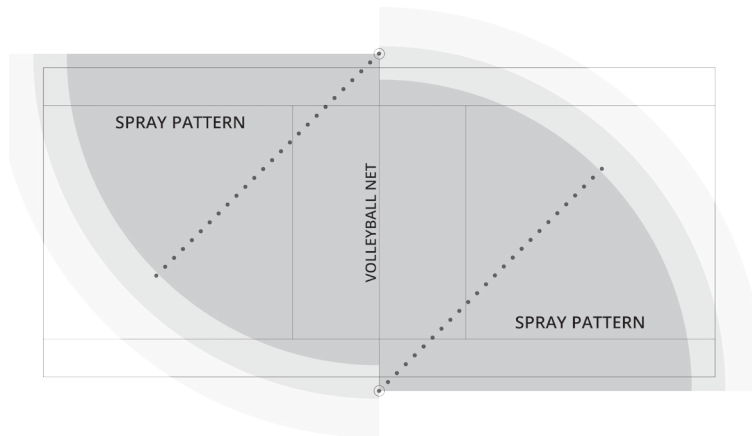

Adjustable Spray Pattern
40 to 360 Degrees

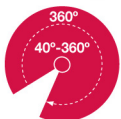

3/4" Threaded Insert
for Easy Installation



Volleyball Misting System

Model	Description	Price
22-MIST	(2) 52SA Misting Heads & Internal Plumbing	\$150

VOLLEYBALL HARDWARE

PW manufactures a complete line of fittings and hardware accessories for our most popular sizes of volleyball posts. All of our net post fittings are treated to protect against the elements of weather and potential corrosion. When you purchase a complete post set, all appropriate hardware and fittings are provided. Should you wish to purchase additional hardware and fittings for existing posts, or as replacement parts, please refer to the following chart.



Model #604-044
Rope Clamp with S-Hook



Model #8321-03NT
Net Tightener with removable handle.



Model #8321-03C
Adjustable Collar



Model #8321-03SP
Adjustable Collar

Rope Clamp with S-Hook

Model	Description	Price
604-044	Rope Clamp with S-Hook	\$27

Volleyball Hardware

Model	Description	Net Tightener	Side Pulley	Adjustable Collar
8321-02	2-7/8" O.D.	\$155	\$71	\$45
8321-03	3-1/2" O.D.	\$162	\$76	\$51
8321-04	4-1/2" O.D.	\$169	\$82	\$62
8321-05	5-9/16" O.D.	\$165	\$89	\$68



Model #8310
Brass Cap Tool

Post Extension for Sand Volleyball

All of our posts found on pages 18-20 are designed to be 8'6" above the playing surface. When ordering posts for your sand volleyball court an additional length of post will be added to accommodate the depth of the sand. Please specify additional length at time of order.

Post Extension for Sand Volleyball

Model	Description	Per Foot Upcharge
2214-EXT	Post Extension for 2-7/8" O.D.	\$59
2216-EXT	Post Extension for 3-1/2" O.D.	\$93
2217-EXT	Post Extension for 4-1/2" O.D.	\$103
2218-EXT	Post Extension for 5-9/16" O.D.	\$125
2219-04EXT	Post Extension for 4" Square	\$146
2219-05EXT	Post Extension for 5" Square	\$156

Game Post Ground Sleeves

Model	Description	No Cap	Hinged Cap	Neoprene Cap	Brass Cap
8301-24	2-3/8" O.D.	\$74	\$164	\$107	\$133
8302-24	2-7/8" O.D.	\$78	\$168	\$113	\$141
8303-24	3-1/2" O.D.	\$107	\$197	\$141	\$182
8304-24	4-1/2" O.D.	\$169	N/A	\$247	\$256
8305-24	5-9/16" O.D.	\$173	N/A	\$256	\$273

Replacement Ground Sleeve Caps

Model	Description	Hinged Cap	Neoprene Cap	Brass Cap
8312	Hinged Cap, Fits #8301, 8302, 8303	\$120	N/A	N/A
8301-1	Cap, 2-3/8" O.D. for 8301 Series	N/A	\$63	\$68
8302-1	Cap, 2-7/8" O.D. for 8302 Series	N/A	\$68	\$75
8303-1	Cap, 3-1/2" O.D. for 8303 Series	N/A	\$74	\$81
8304-1	Cap, 4-1/2" O.D. for 8304 Series	N/A	\$78	\$87
8305-1	Cap, 5-9/16" O.D. for 8305 Series	N/A	\$83	\$100
8310	Brass Cap Tool	N/A	N/A	\$42

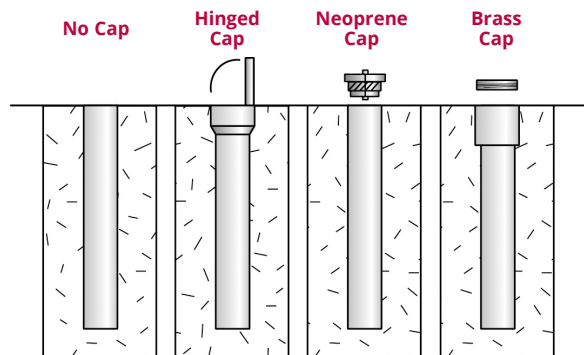

TETHERBALL POSTS

Our tetherball posts are manufactured of heavy-duty, galvanized steel for maximum strength and durability. Installed posts stand 10 feet and come with a welded cap. Each post is equipped with a 3/8" plated eyebolt, 30" plated chain (7/32" diameter) and a swivel snap for ball attachment. Our tetherballs are regulation size and shape and are manufactured of a fully molded butyl bladder and nylon.

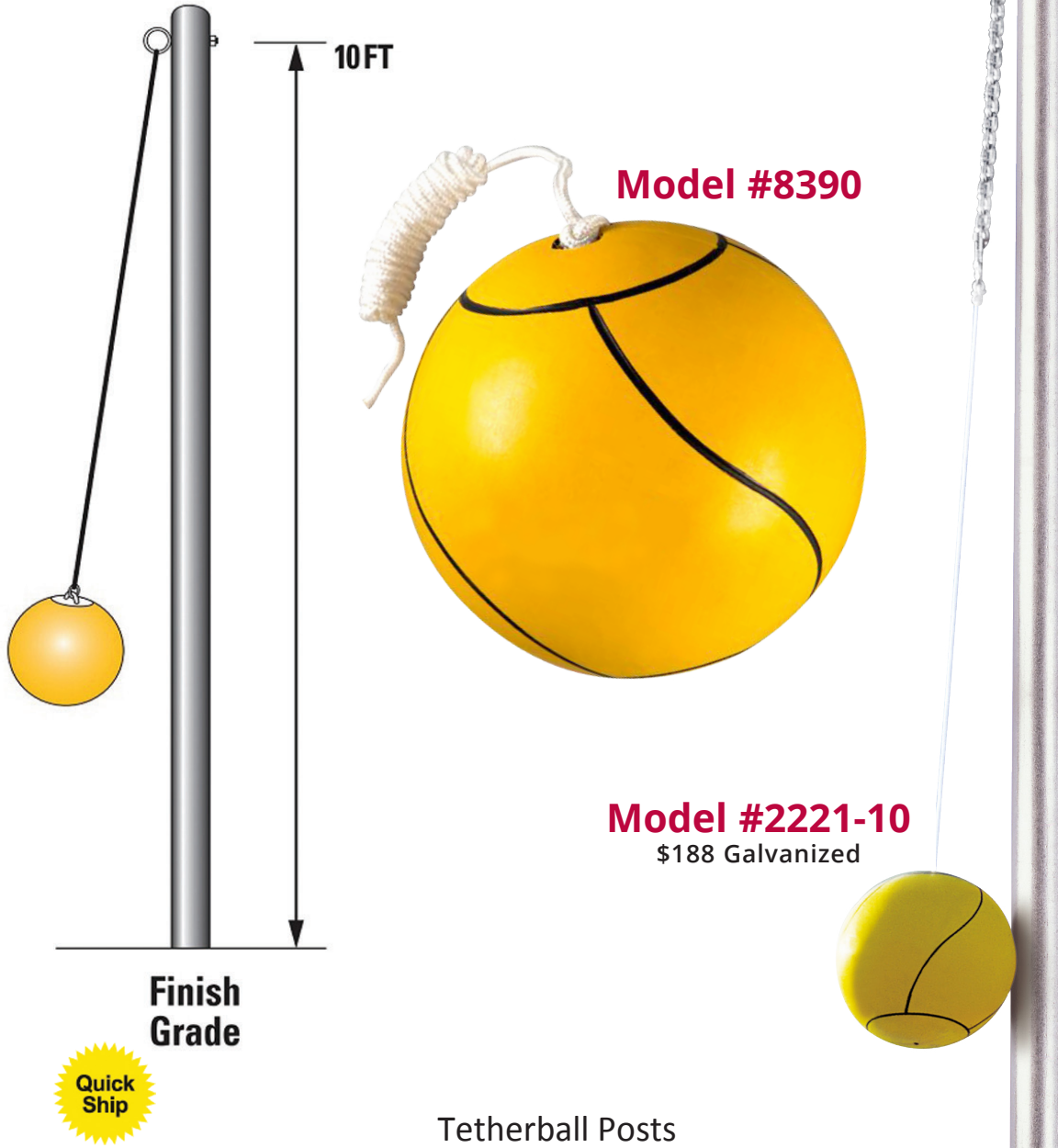

Tetherball Posts

Model	Description	Weight	Price
2221-10	2-3/8" O.D. Tetherball Post with Ball	50 lbs.	\$188
2221-20	Two Piece 2-3/8" O.D. Tetherball Post with Ball	59 lbs.	\$209
8390	Replacement Tetherball with Ball and Rope	2 lbs.	\$49

Quick Ship

Quick Ship

Quick Ship

COURT SPORT POSTS

Manufactured of 3-1/2" O.D. Galvanized steel, these posts include all necessary hardware for proper net attachment. Post 1 has 2 fixed eyes. Post 2 has standard net tightener with removable handle, and a top or side pulley (depending on model number selected). All posts come galvanized as standard. Powder coat colors on page 2.

Quick Ship



Model #2201-11
\$633 Powder Coated



Model #2201-20
\$698 Powder Coated



Quick Ship

Tennis & Pickleball Posts

Model	Post Size	Post 1	Post 2	Weight	Powder Coat Price	Galvanized Price
2201-11	Tennis 3-1/2" O.D.	2 Fixed Eyes	1 Fixed Eye, Net Tightener with Removable Handle, Top Pulley	117 lbs.	\$633 pr.	\$466 pr.
2201-20	Tennis 3-1/2" O.D.	2 Fixed Eyes	2 Fixed Eyes, Net Tightener with Removable Handle, Top Pulley	120 lbs.	\$698 pr.	\$529 pr.
2202-11	Pickleball 3-1/2" O.D.	2 Fixed Eyes	1 Fixed Eye, Net Tightener with Removable Handle, Top Pulley	117 lbs.	\$551 pr.	\$419 pr.
2202-20	Pickleball 3-1/2" O.D.	2 Fixed Eyes	2 Fixed Eyes, Net Tightener with Removable Handle, Top Pulley	120 lbs.	\$604 pr.	\$471 pr.

Quick Ship
Quick Ship

COURT SPORT GROUND SLEEVES

Tennis & Pickleball 3-1/2" Post Ground Sleeves

Model	Description	Weight	Price
8303-24-2	Ground Sleeve 24", No Cap (Pair)	60 lbs.	\$214 pr.
8303-24-2H	Ground Sleeve 24", Hinged Cap (Pair)	64 lbs.	\$394 pr.
8303-24-2N	Ground Sleeve 24", Neoprene Cap (Pair)	64 lbs.	\$283 pr.
8303-24-2B	Ground Sleeve 24", Brass Screw Cap (Pair)	68 lbs.	\$364 pr.

Quick Ship
Quick Ship
Quick Ship
Quick Ship

TENNIS & PICKLEBALL POSTS

HEAVY-DUTY TENNIS POSTS

Every post features an internal top cap to help seal out the elements. All of our posts are designed to permit 24" of depth for in-ground sleeves or permanent concrete footings.

The standard post color is green, which can be Quick Shipped, black is available at standard lead times. Nets sold separately - see below.

- Posts are 3" O.D. round or 3" square, 11-gauge steel
- Cast aluminum alloy caps and gear housings
- Baked-on polyester powder coat finish
- Chrome plated gear plate and handle
- Internally wound with a self-locking gear mechanism
- Plated, steel gears
- Case hardened small gear



Model #2206-GR

\$807 per pair

Model #2205-GR

\$802 per pair



Quick Ship

Heavy-Duty Tennis Posts

Model	Description	Weight	Price
2205-BLK	Square Tennis Posts (Black) - 1 Pair	50 lbs.	\$802
2205-GR	Square Tennis Posts (Green) - 1 Pair	50 lbs.	\$802
2206-BLK	Round Tennis Posts (Black) - 1 Pair	50 lbs.	\$807
2206-GR	Round Tennis Posts (Green) - 1 Pair	50 lbs.	\$807
2206-01	3" Round Sleeve with Cap	10 lbs.	\$103
8303A-SQ24-2	Aluminum Sleeve for Model #2205	8 lbs.	\$97
8303A-1S	Square Caps for Aluminum Sleeve	9 lbs.	\$89

Tennis Post Replacement Parts

Model	Description	Weight	Price
8410-SQBK	Repl. Cap with Pulley - Square Black	10 lbs.	\$78
8410-SQGR	Repl. Cap with Pulley - Square Green	10 lbs.	\$78
8410-RDBK	Repl. Cap with Pulley - Round Black	10 lbs.	\$78
8410-RDGR	Repl. Cap with Pulley - Round Green	10 lbs.	\$78
8411-SQBK	Repl. Cap for 2nd Post - Square Black	10 lbs.	\$72
8411-SQGR	Repl. Cap for 2nd Post - Square Green	10 lbs.	\$72
8411-RDBK	Repl. Cap for 2nd Post - Round Black	10 lbs.	\$72
8411-RDGR	Repl. Cap for 2nd Post - Round Green	10 lbs.	\$72
8412-RD	Repl. Gear Assembly - Round	3 lbs.	\$180
8412-SQ	Repl. Gear Assembly - Square	3 lbs.	\$189
615-024	Repl. Cap for 2nd Post	1 lbs.	\$69
615-025	Repl. Winder Handle	1 lbs.	\$79

COURT SPORT HARDWARE

PW manufactures a complete line of fittings and hardware accessories for our most popular tennis posts. All of our net post fittings and hardware are hot dip galvanized after fabrication (except net tightener with removable handle) to protect against the elements of weather and potential corrosion.



Model #8321-03NT
Net Tightener with Removable Handle



Model #8321-03SP
Side Pulley



Model #8321-03TP
Top Pulley



Model #8371-20
Ground Anchor



Model #8371-30
Net Tie Down Strap

Court Sport Hardware

Model	Description	Weight	Price
8321-03NT	3-1/2" O.D. Net Tightener with Removable Handle (Black Only)	10 lbs.	\$162
8321-03TP	3-1/2" O.D. Top Pulley (Galvanized)	4 lbs.	\$88
8321-03SP	3-1/2" O.D. Side Pulley (Galvanized)	5 lbs.	\$76
8371-20	Ground Anchor	2 lbs.	\$46
8371-30	Net Tie Down Strap	2 lbs.	\$41

CHAMPION & PREMIUM COURT SPORT NETS

Our Tennis Nets are manufactured with braided, 3mm black nylon mesh with a 1-3/4" size. The top binding is manufactured of 2-1/2" white PVC tarp and features a steel cable rope, with the side and bottom bindings made of 1-1/2" white PVC tarp. The Premium Net features 42" wood dowels inside the side bindings.



Champion & Premium Court Sport Nets

Model	Description	Weight	Price
8353	Champion Tennis Net, 42' x 3-1/2'	15 lbs.	\$321
8352	Premium Tennis Net, 42' x 3-1/2'	19 lbs.	\$368
8354	Pickleball Net, 22' x 36"	15 lbs.	\$314

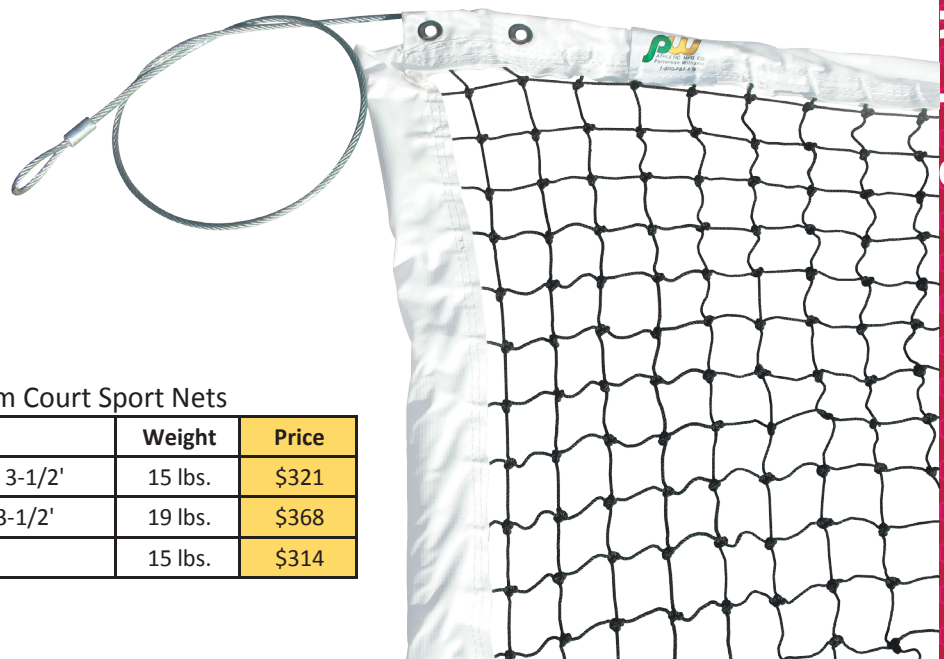

SOCCER GOALS



Manufactured of 2" x 4" aluminum or galvanized steel crossbars and support posts with 2-3/8" O.D. Galvanized end frames. Crossbars are Powder Coated white. Available in 4 sizes, these goals come complete with Heavy-Duty Soccer Nets, and Ties. Portable models include #8347 Auger Style Anchoring System.

2" x 4" Soccer Goals - Complete System (4'2" x 6')

Model	Description	Weight	Price	Recommended Ground Sleeves
2239-06A	Aluminum Goals with End Frames (Portable)	N/A	\$2,199	8346-30(4) 2 Per Frame
2239-06	Steel Goals with End Frames (Portable)	N/A	\$2,299	8346-30(4) 2 Per Frame

2" x 4" Soccer Goals - Complete System (6'6" x 12')

Model	Description	Weight	Price	Recommended Ground Sleeves
2238-12A	Aluminum Goals without Net Supports (Permanent)	198 lbs.	\$1,668	8324-24(4)
2238-12G	Steel Goals without Net Supports (Permanent)	295 lbs.	\$1,722	8324-24(4)
2238-13A	Aluminum Goals with 2 Net Supports (Permanent)	380 lbs.	\$2,044	8324-24(4), 8301-24(4)
2238-13G	Steel Goals with 2 Net Supports (Permanent)	486 lbs.	\$2,124	8324-24(4), 8301-24(4)
2239-12A	Aluminum Goals with End Frames (Portable)	500 lbs.	\$2,466	8346-30(4) 2 Per Frame
2239-12G	Steel Goals with End Frames (Portable)	670 lbs.	\$2,687	8346-30(4) 2 Per Frame

2" x 4" Soccer Goals - Complete System (6'6" x 18')

Model	Description	Weight	Price	Recommended Ground Sleeves
2238-18A	Aluminum Goals without Net Supports (Permanent)	198 lbs.	\$1,836	8324-24(4)
2238-18G	Steel Goals without Net Supports (Permanent)	351 lbs.	\$1,952	8324-24(4)
2238-19A	Aluminum Goals with 2 Net Supports (Permanent)	410 lbs.	\$2,109	8324-24(4), 8301-24(4)
2238-19G	Steel Goals with 2 Net Supports (Permanent)	542 lbs.	\$2,291	8324-24(4), 8301-24(4)
2239-18A	Aluminum Goals with End Frames (Portable)	536 lbs.	\$2,561	8346-30(4) 2 Per Frame
2239-18G	Steel Goals with End Frames (Portable)	726 lbs.	\$2,690	8346-30(4) 2 Per Frame

2" x 4" Soccer Goals - Complete System (7' x 21')

Model	Description	Weight	Price	Recommended Ground Sleeves
2238-21A	Aluminum Goals without Net Supports (Permanent)	220 lbs.	\$1,887	8324-24(4)
2238-21G	Steel Goals without Net Supports (Permanent)	390 lbs.	\$1,952	8324-24(4)
2238-22A	Aluminum Goals with 2 Net Supports (Permanent)	456 lbs.	\$2,466	8324-24(4), 8301-24(4)
2238-22G	Steel Goals with 2 Net Supports (Permanent)	602 lbs.	\$2,441	8324-24(4), 8301-24(4)
2239-21A	Aluminum Goals with End Frames (Portable)	536 lbs.	\$2,781	8346-30(4) 2 Per Frame
2239-21G	Steel Goals with End Frames (Portable)	726 lbs.	\$2,931	8346-30(4) 2 Per Frame

2" x 4" Soccer Goals - Complete System (8' x 24')

Model	Description	Weight	Price	Recommended Ground Sleeves
2238-00A	Aluminum Goals without Net Supports (Permanent)	244 lbs.	\$2,057	8324-24(4)
2238-00G	Steel Goals without Net Supports (Permanent)	434 lbs.	\$2,115	8324-24(4)
2238-01A	Aluminum Goals with 2 Net Supports (Permanent)	480 lbs.	\$2,582	8324-24(4), 8301-24(4)
2238-01G	Steel Goals with 2 Net Supports (Permanent)	670 lbs.	\$2,690	8324-24(4), 8301-24(4)
2238-03A	Aluminum European Style Goals (Permanent)	332 lbs.	\$2,351	8324-24(4)
2238-03G	Steel European Style Goals (Permanent)	522 lbs.	\$2,437	8324-24(4)
2239-00A	Aluminum Goals with End Frames (Portable)	569 lbs.	\$2,926	8346-30(4) 2 Per Frame
2239-00G	Steel Goals with End Frames (Portable)	759 lbs.	\$3,090	8346-30(4) 2 Per Frame



Front View

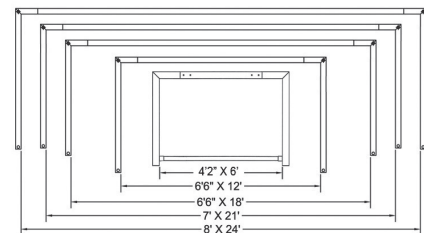

Side Views

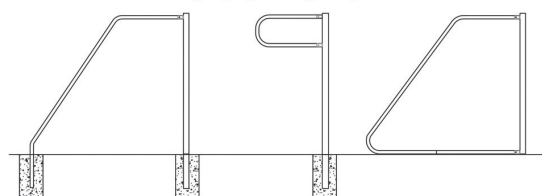

Standard Goal with Net Supports (Permanent)

Standard Goal with European Backstays (Permanent)

Standard Goal with End-Frames (Portable)

**Note: Ground Sleeves for our Permanent Goals are available. This add-on purchase gives the consumer the option of having a permanent goal that is also removable, Perfect for multi-purpose sports fields. Our Ground Sleeve and Augur options can be found on Page 34. **

HEAVY-DUTY NCAA REGULATION GOALS



Our NCAA regulation soccer goals are made to meet some of the most stringent requirements for today's competitive programs. Providing a front opening of 8'x24', the uprights and crossbars are manufactured of 4" square galvanized steel or aluminum and are powder coated white. Net supports and end frames are manufactured of 2-3/8" O.D. Galvanized steel. Auger style anchors #8347 are included on portable models. Optional anchors and ground sleeves are available to meet your specific requirements.

Heavy-Duty NCAA Regulation Goals

Model	Description	Weight	Price	Recommended Ground Sleeves
2236-00A	Aluminum Goals without Net Supports (Permanent)	300 lbs.	\$2,607	8304-SQ24(4)
2236-00G	Steel Goals without Net Supports (Permanent)	554 lbs.	\$2,694	8304-SQ24(4)
2236-01A	Aluminum Goals with 2 Net Supports (Permanent)	526 lbs.	\$3,080	8304-SQ24(4), 8301-24(4)
2236-01G	Steel Goals with 2 Net Supports (Permanent)	780 lbs.	\$3,127	8304-SQ24(4), 8301-24(4)
2236-02A	Aluminum Goals with 3 Net Supports (Permanent)	800 lbs.	\$3,251	8304-SQ24(4), 8301-24(6)
2236-02G	Steel Goals with 3 Net Supports (Permanent)	820 lbs.	\$3,318	8304-SQ24(4), 8301-24(6)
2236-03A	Aluminum Goals with European-Style Net Supports (Permanent)	340 lbs.	\$2,910	8304-SQ24(4)
2236-03G	Steel Goals with European-Style Net Supports (Permanent)	595 lbs.	\$2,941	8304-SQ24(4)
2237-01A	Aluminum Goals with End Frames (Portable)	696 lbs.	\$3,619	8346-30(4) 2 Per Frame
2237-01G	Steel Goals with End Frames (Portable)	998 lbs.	\$3,682	8346-30(4) 2 Per Frame

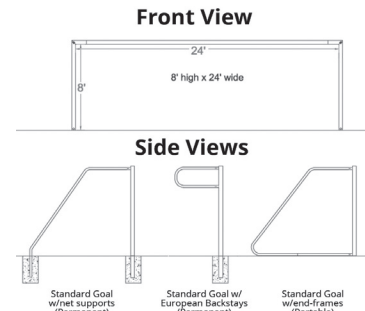

**Note: Ground Sleeves for our Permanent Goals are available. This add-on purchase gives the consumer the option of having a permanent goal that is also removable, Perfect for multi-purpose sports fields. Our Ground Sleeve and Augur options can be found on Page 34. **

EXTRA HEAVY-DUTY NCAA REGULATION GOALS



Model #2235-00
\$3,958 per pair

This heavy-duty portable regulation soccer goal features two top crossbars and three net supports, all made of 2-3/8" O.D. Galvanized steel. The front opening measures 8' x 24' and is constructed of 4" square galvanized steel or aluminum and are powder coated white. Auger style anchors #8347 are included. Optional anchor system and ground sleeves are available to meet your specific requirements.

Extra Heavy-Duty NCAA Regulation Goals

Model	Description	Weight	Price	Recommended Ground Sleeves
2235-00	Heavy-Duty Steel Goals with 3 Net Supports (Portable)	1,050 lbs.	\$3,958	8346-30(4) 2 Per Frame
2235-00A	Heavy-Duty Aluminum Goals with 3 Net Supports (Portable)	1,005 lbs.	\$3,899	8346-30(4) 2 Per Frame

⚠ CONSUMER PRODUCT SAFETY ALERT ⚠

Warning: Moveable Soccer goals can tip over and cause serious injury or death to children who climb on them or hang from the crossbar.

The USCPSC (US Consumer Product Safety Commission) has determined that portable official soccer goals should be anchored or counter-weighted at all times. For a complete set of the "guidelines" for portable soccer goal safety and warning labels call PW Athletic Mfg. Co. customer service at: 1-800-687-5768



SOCCER GOALS

Nets & Ties Sold Separately



Model #2231-00A
\$3,044 per pair

ROUND SOCCER GOALS

These 4-1/2" O.D. round goals are manufactured of galvanized steel or aluminum with 2-3/8" O.D. net supports. Crossbar and uprights are powder coated white. Goals are available in 4 sizes to accommodate all age groups. Augers style anchors #8347 are included on portable models. Optional anchors and ground sleeves are available to meet your specific requirements.

FIELD SPORTS

Front View

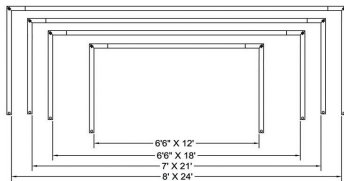

Side Views

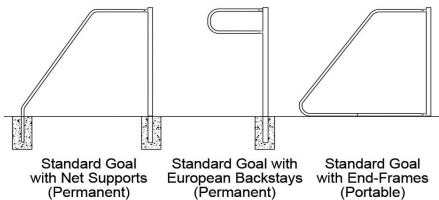

Round Soccer Goals (6'6" x 12')

Model	Description	Weight	Price	Recommended Ground Sleeves
2230-12A	Round Aluminum Goals without Net Supports (Permanent)	177 lbs.	\$1,742	8304-24(4)
2230-12G	Round Steel Goals without Net Supports (Permanent)	325 lbs.	\$1,886	8304-24(4)
2230-13A	Round Aluminum Goals with 2 Net Supports (Permanent)	412 lbs.	\$2,067	8304-24(4), 8301-24(4)
2230-13G	Round Steel Goals with 2 Net Supports (Permanent)	563 lbs.	\$2,253	8304-24(4), 8301-24(4)
2231-12A	Round Aluminum Goals with End Frames (Portable)	472 lbs.	\$2,418	8346-30(4) 2 Per Frame
2231-12G	Round Steel Goals with End Frames (Portable)	621 lbs.	\$2,522	8346-30(4) 2 Per Frame

Round Soccer Goals (6'6" x 18')

Model	Description	Weight	Price	Recommended Ground Sleeves
2230-18A	Round Aluminum Goals without Net Supports (Permanent)	331 lbs.	\$2,107	8304-24(4)
2230-18G	Round Steel Goals without Net Supports (Permanent)	648 lbs.	\$2,297	8304-24(4)
2230-19A	Round Aluminum Goals with 2 Net Supports (Permanent)	566 lbs.	\$2,403	8304-24(4), 8301-24(4)
2230-19G	Round Steel Goals with 2 Net Supports (Permanent)	886 lbs.	\$2,607	8304-24(4), 8301-24(4)
2231-18A	Round Aluminum Goals with End Frames (Portable)	626 lbs.	\$2,571	8346-30(4) 2 Per Frame
2231-18G	Round Steel Goals with End Frames (Portable)	944 lbs.	\$2,830	8346-30(4) 2 Per Frame

Round Soccer Goals (7' x 21')

Model	Description	Weight	Price	Recommended Ground Sleeves
2230-21A	Round Aluminum Goals without Net Supports (Permanent)	424 lbs.	\$2,265	8304-24(4)
2230-21G	Round Steel Goals without Net Supports (Permanent)	842 lbs.	\$2,358	8304-24(4)
2230-22A	Round Aluminum Goals with 2 Net Supports (Permanent)	659 lbs.	\$2,518	8304-24(4), 8301-24(4)
2230-22G	Round Steel Goals with 2 Net Supports (Permanent)	1080 lbs.	\$2,760	8304-24(4), 8301-24(4)
2231-21A	Round Aluminum Goals with End Frames (Portable)	719 lbs.	\$2,687	8346-30(4) 2 Per Frame
2231-21G	Round Steel Goals with End Frames (Portable)	1138 lbs.	\$2,937	8346-30(4) 2 Per Frame

Round Soccer Goals (8' x 24')

Model	Description	Weight	Price	Recommended Ground Sleeves
2230-00A	Round Aluminum Goals without Net Supports (Permanent)	476 lbs.	\$2,288	8304-24(4)
2230-00G	Round Steel Goals without Net Supports (Permanent)	950 lbs.	\$2,347	8304-24(4)
2230-01A	Round Aluminum Goals with 2 Net Supports (Permanent)	711 lbs.	\$2,603	8304-24(4), 8301-24(4)
2230-01G	Round Steel Goals with 2 Net Supports (Permanent)	1188 lbs.	\$2,807	8304-24(4), 8301-24(4)
2230-03A	Round Aluminum European Style Goals (Permanent)	566 lbs.	\$2,506	8304-24(4)
2230-03G	Round Steel European Style Goals (Permanent)	1041 lbs.	\$2,722	8304-24(4)
2231-00A	Round Aluminum Goals with End Frames (Portable)	771 lbs.	\$3,044	8346-30(4) 2 Per Frame
2231-00G	Round Steel Goals with End Frames (Portable)	1246 lbs.	\$3,303	8346-30(4) 2 Per Frame

CONSUMER PRODUCT SAFETY ALERT

Warning: Moveable Soccer goals can tip over and cause serious injury or death to children who climb on them or hang from the crossbar.

The USCPSC (US Consumer Product Safety Commission) has determined that portable official soccer goals should be anchored or counter-weighted at all times. For a complete set of the "guidelines" for portable soccer goal safety and warning labels call PW Athletic Mfg. Co. customer service at: 1-800-687-5768

**Note: Ground Sleeves for our Permanent Goals are available. This add-on purchase gives the consumer the option of having a permanent goal that is also removable. Perfect for multi-purpose sports fields. Our Ground Sleeve and Augur options can be found on Page 34. **

SOCCER GOALS



Ideal for programs on smaller budgets. Our youth goals are easily dismantled for quick storage. Goals have a front opening of 8' x 24' and features uprights and crossbars manufactured of 2-3/8" O.D. Galvanized steel. Call for pricing on smaller goal sizes.

Youth Goals

Model	Description	Weight	Price	Recommended Ground Sleeves
2233-00	Youth Goals 8' x 24' without Net Supports (Permanent)	350 lbs.	\$1,198	8301-24(4)
2233-01	Youth Goals 8' x 24' with 2 Net Supports (Permanent)	500 lbs.	\$1,349	8301-24(4), 8301-24(4)
2233-31	Youth Goals 8' x 24' with End Frames (Portable)	575 lbs.	\$1,589	8346-30(4) 2 Per Frame

****Note:** Ground Sleeves for our Permanent Goals are available. This add-on purchase gives the consumer the option of having a permanent goal that is also removable, Perfect for multi-purpose sports fields. Our Ground Sleeve and Augur options can be found on Page 34. **

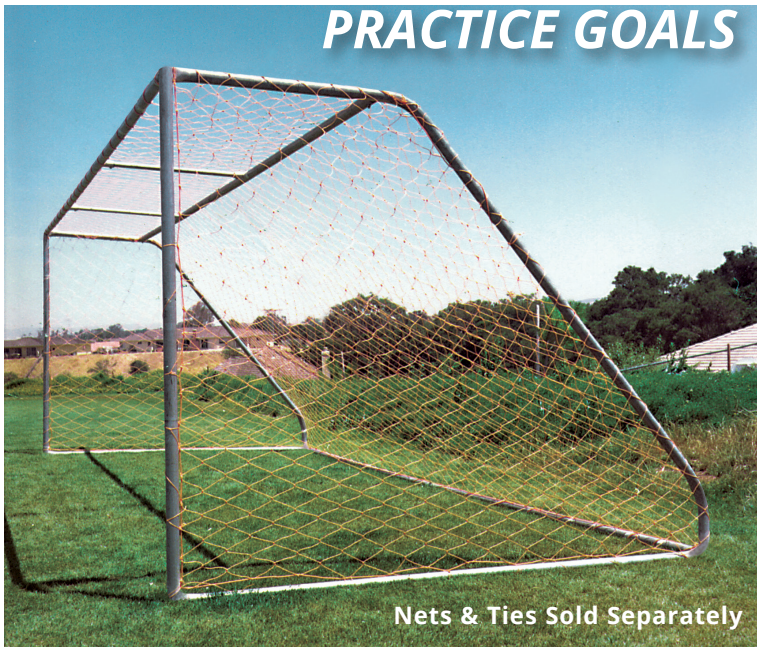

Model #2232-00

\$2,277 per pair Galvanized

These heavy-duty 8'H x 24'W goals are made to take the tough punishment of aggressive practices. Manufactured completely of 2-3/8" O.D. Galvanized steel, this goal features two top crossbars reinforced with diagonal supports. Auger type anchors are included.



Practice Soccer Goal Sets

Model	Description	Weight	Powder Coat Price	Galvanized Price	Recommended Ground Sleeves
2232-00	2-3/8" O.D. Galvanized Steel, 8'H 24'W Goals (Portable), Net not included	650 lbs.	\$2,688	\$2,169	8346-30(4) 2 Per Frame
2239-06A	Complete 2" x 4" System, 4'H x 6'W with end frames, (Portable) Aluminum	N/A	\$2,199	NA	8346-30(4) 2 Per Frame

⚠ CONSUMER PRODUCT SAFETY ALERT ⚠

Warning: Moveable Soccer goals can tip over and cause serious injury or death to children who climb on them or hang from the crossbar.

The USCPSC (US Consumer Product Safety Commission) has determined that portable official soccer goals should be anchored or counter-weighted at all times. For a complete set of the "guidelines" for portable soccer goal safety and warning labels call PW Athletic Mfg. Co. customer service at: 1-800-687-5768

NETS & ACCESSORIES



Model #8368
Steel Net Stakes



Model #8400-04
Heavy-Duty Corner Flags

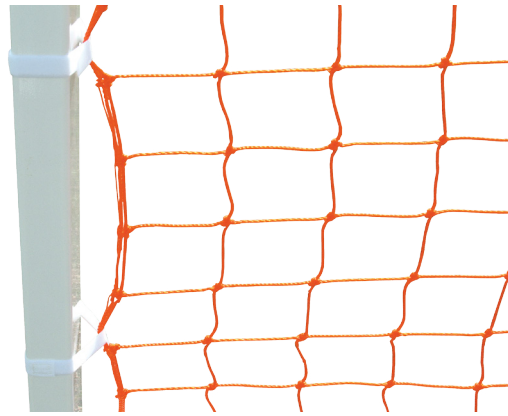

Model #8366
Heavy-Duty Soccer Net



Model #8373
Nylon Velcro Net Ties

Nets and Accessories

Model	Description	Color	Weight	Price
8366	8' x 24' Heavy-Duty Soccer Nets	Orange	34 lbs.	\$237
8367-W	8' x 24' Premium Heavy-Duty Soccer Nets	White	50 lbs.	\$407
8367-O	8' x 24' Premium Heavy-Duty Soccer Nets	Orange	50 lbs.	\$428
8385	6'6" x 12' Heavy-Duty Soccer Nets	Orange	16 lbs.	\$170
8381	6'6" x 18' Heavy-Duty Soccer Nets	Orange	20 lbs.	\$177
8380	7' x 21' Heavy-Duty Soccer Nets	Orange	26 lbs.	\$211
8368	16 Steel Net Stakes	N/A	4 lbs.	\$62
8373	24 Nylon Velcro Net Ties	N/A	2 lbs.	\$55
8400-04	Heavy-Duty Soccer Field Corner Flags (Set of 4)	N/A	8 lbs.	\$102



Model #8344
Portable Goal Hand truck

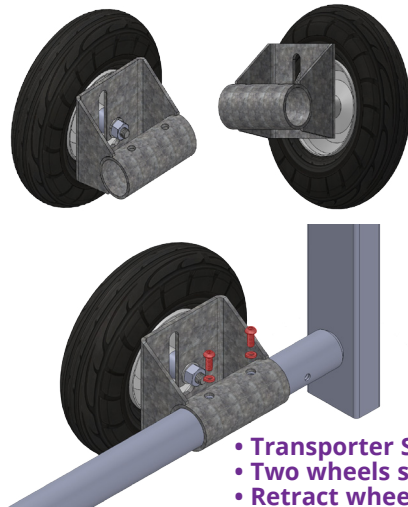

- Transporter System for Portable Goals
- Two wheels set back from front, tilt to move
- Retract wheels for play

Transporter System

Model	Choice of Wheels	Weight	Price
8343-02	2 Pneumatic Wheels, 16" x 3.5"	30 lbs.	\$382
8343-04	4 Pneumatic Wheels, 16" x 3.5"	60 lbs.	\$641
8342-02	2 Solid Rubber Wheels, 16" x 3.5"	57 lbs.	\$539
8342-04	4 Solid Rubber Wheels, 16" x 3.5"	104 lbs.	\$705
8344	Portable Goal Handtruck	50 lbs.	\$129

Soccer Goal Ground Sleeves & Augers

Model	Description	Weight	Price
8301-24-4	Ground Sleeve for 2-3/8" O.D. x 24" without Caps (Set of 4)	60 lbs.	\$294
8301-24-4N	Ground Sleeve for 2-3/8" O.D. x 24" with Neoprene Caps (Set of 4)	65 lbs.	\$428
8302-36-4	Ground Sleeve for 2-7/8" O.D. x 36" without Caps (Set of 4)	100 lbs.	\$340
8302-36-4N	Ground Sleeve for 2-7/8" O.D. x 36" with Neoprene Caps (Set of 4)	105 lbs.	\$612
8304-24-4	Ground Sleeve for 4-1/2" O.D. x 24" without Caps (Set of 4)	100 lbs.	\$676
8304-24-4N	Ground Sleeve for 4-1/2" O.D. x 24" with Neoprene Caps (Set of 4)	105 lbs.	\$988
8304-SQ24-4	Ground Sleeves for 4x4" Posts x 24" without Caps (Set of 4)	100 lbs.	\$500
8304-SQ24-4N	Ground Sleeves for 4x4" Posts x 24" with Neoprene Caps (Set of 4)	110 lbs.	\$540
8324-24-4	Ground Sleeve for 2x4" Complete Goal Systems without Caps (Set of 4)	100 lbs.	\$456
8324-24-4N	Ground Sleeve for 2x4" Complete Goal Systems with Neoprene Caps (Set of 4)	110 lbs.	\$494
8346-30	Sleeved Anchors without Caps for all Portable Soccer Goals (Set of 4)	50 lbs.	\$238
8346-30N	Sleeved Anchors with Neoprene Caps for all Portable Soccer Goals (Set of 4)	60 lbs.	\$313
8347	Augers with Chain and Clamps for all Portable Soccer Goals (Set of 4)	10 lbs.	\$156

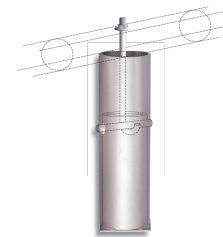

Model #8346-30
J-Hook Illustration
Inside of sleeve

MODEL #8347 - AUGER ANCHOR SYSTEM WITH CHAIN & CLAMP (10 LBS)
(Set of 4)

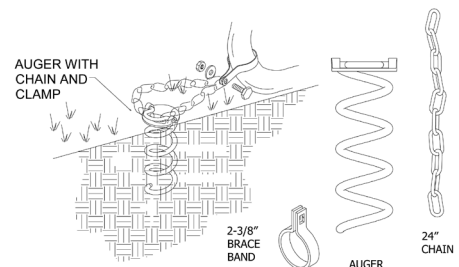

FOOTBALL GOALS

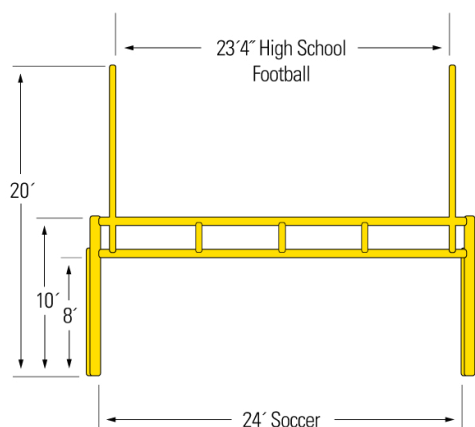

COMBINATION FOOTBALL/SOCCER GOALS

Our combination Football / Soccer Goals provide the perfect solution for multi-purpose field use. This unit is manufactured of 2-7/8" O.D. Galvanized steel with a 2-3/8" O.D. net supports.

The crossbar truss provides 8-foot height for soccer and 10-foot height for football. Goals can be installed in concrete footings or in optional ground sleeves.

Combination Football/Soccer Goals

Model	Description	Weight	Powder Coat Price	Galvanized Price	Recommended Ground Sleeves
2224-00	Pair Combo Goals, No Net Supports, (Permanent)	900 lbs.	\$3,644	\$2,699	8302-36(4)
2224-01	Pair Combo Goals, 2 Net Supports, (Permanent)	1,050 lbs.	\$3,990	\$3,044	8302-36(4), 8301-24(4)
2224-02	Pair Combo Goals, 3 Net Supports, (Permanent)	1,125 lbs.	\$4,185	\$3,240	8302-36(4), 8301-24(6)
2224-03	Pair Combo Goals, 2 Net Supports, (Portable)*	1,175 lbs.	\$4,390	\$3,444	8346-30(4) 2 Per Goal

* Includes 8347 Augers with Chain & Clamps (4)

H-TYPE FOOTBALL GOAL POSTS

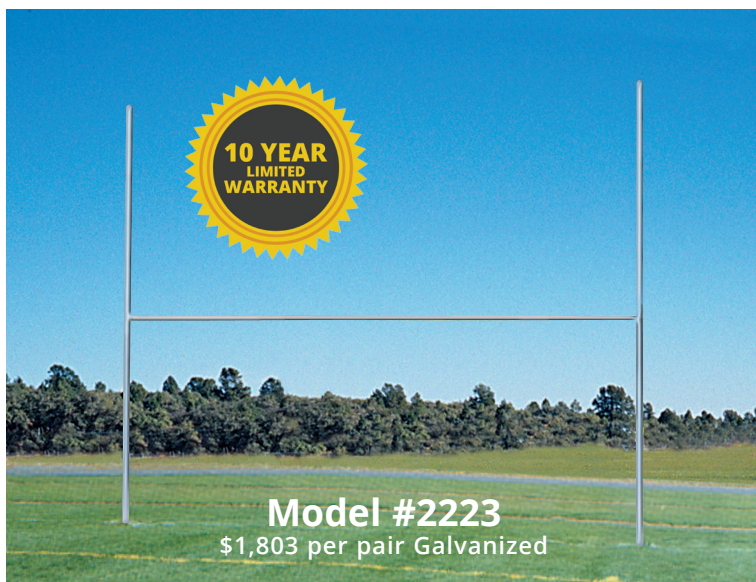

PW offers those on a smaller budget our traditional H-Type goalposts. These 3-1/2" O.D. uprights and 2-3/8" O.D. goalposts can be installed permanently or placed in our 36" deep ground sleeves for easy removal. All pricing and models reflect a pair of goals. Goals come galvanized as standard, powder coat colors on page 2. Current NFHSA rules and regulations call for white or yellow uprights.

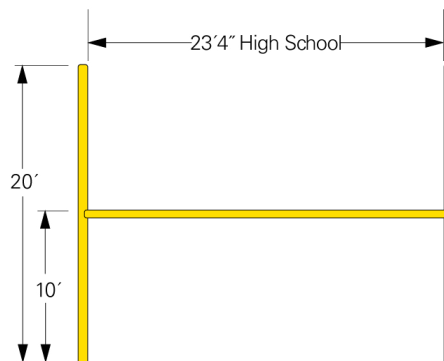

H-Type Football Goal Posts

Model	Description	Weight	Powder Coat Price	Galvanized Price
2223	H-Type Goals with 10' Uprights	857 lbs.	\$2,575	\$1,803
8303-36-4	Sleeves without Caps for Model 2223 (Set of 4)	110 lbs.	N/A	\$508
8303-36-4N	Sleeves with Neoprene Caps for Model 2223 (Set of 4)	115 lbs.	N/A	\$788

FOOTBALL GOALS

SINGLE-POST GOOSENECK STYLE GOAL POSTS

Our regulation Single Post Goalposts are designed of heavy-duty Schedule 40 galvanized steel. The crossbar is made of 3-1/2" O.D. and the 20' uprights are 2-3/8" O.D. Uprights are equipped with Wind Flags as standard

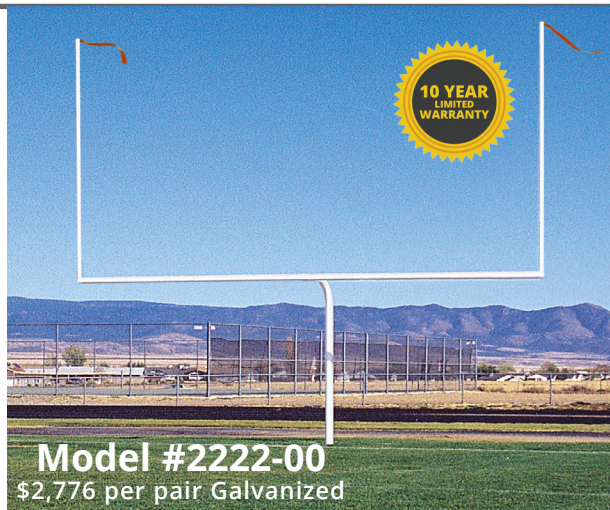

Model #2222-00
\$2,776 per pair Galvanized



Model #2225-00
\$4,188 per pair Powder Coated

Single-Post Gooseneck Style Goal Posts

Model	Description	Weight	Powder Coat Price	Galvanized Price
2222-00	4-1/2" O.D., with 4' Offsets, 23'4" Wide High School Goals	820 lbs.	\$3,882	\$2,776
2222-18	4-1/2" O.D., with 4' Offsets, 18'6" Wide College Goals	900 lbs.	\$3,903	\$2,780
2222-20	5-9/16" O.D., with 6' Offsets, 23'4" Wide High School Goals	1,200 lbs.	\$4,617	\$3,510
2222-22	5-9/16" O.D., with 6' Offsets, 18'6" Wide College Goals	1,186 lbs.	\$4,638	\$3,419
2222-23	6-5/8" O.D., with 8' Offsets, 18'6" Wide College Goals	1,345 lbs.	\$7,767	\$6,258
2222-24	6-5/8" O.D., with 8' Offsets, 23'4" Wide High School Goals	1,365 lbs.	\$7,767	\$6,258
8304-48-2	4-1/2" Ground Sleeve 48", No Cap (Pair)	90 lbs.	N/A	\$518
8304-48-2N	4-1/2" Ground Sleeve 48", Neoprene Cap (Pair)	93 lbs.	N/A	\$596
8305-48-2	5-9/16" Ground Sleeve 48", No Cap (Pair)	100 lbs.	N/A	\$530
8305-48-2N	5-9/16" Ground Sleeve 48", Neoprene Cap (Pair)	103 lbs.	N/A	\$696
8306-48-2	6-5/8" Ground Sleeve 48", No Cap (Pair)	110 lbs.	N/A	\$1,048
8306-48-2N	6-5/8" Ground Sleeve 48", Neoprene Cap (Pair)	113 lbs.	N/A	\$1,228
8376-04	Post Pad for round posts up to 4-1/2"OD, (Each)	12 lbs.	N/A	\$464
8376-05	Post Pad for round posts up to 5-9/16"OD, (Each)	15 lbs.	N/A	\$520
8376-06	Post Pad for round posts up to 6-5/8"OD, (Each)	18 lbs.	N/A	\$799
FFLAG	Replacement Wind Flags (Pair)	1 lbs.	N/A	\$25

DUAL-POST GOOSENECK STYLE GOAL POSTS

Our regulation Dual Post Goalposts are designed of heavy-duty Schedule 40 galvanized steel. The support posts are welded together in a stabilizing V-design. The crossbar is made of 3-1/2" O.D. and the 20' uprights are 2-3/8" O.D. Uprights are equipped with Wind Flags as standard

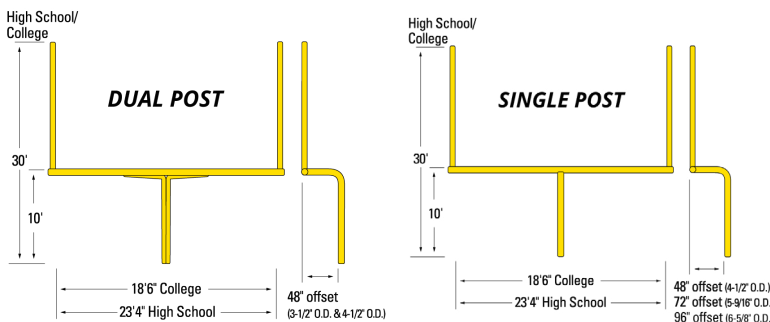

Dual-Post Gooseneck Style Goal Posts

Model	Description	Weight	Powder Coat Price	Galvanized Price
2225-00	3-1/2" O.D. High School Football Dual Post Goal Posts with 4' Offset, 23'4" Wide	975 lbs.	\$4,188	\$3,033
2225-01	3-1/2" O.D. College Dual Post Goal Posts with 4' Offset, 18'6" Wide	1,055 lbs.	\$4,188	\$3,033
2226-00	Dual-Post Gooseneck Goal Posts, 3-1/2" O.D., 23'4" Wide High School Goal with 4' Offsets	1,200 lbs.	\$3,698	\$2,945
2226-01	Dual-Post Gooseneck Goal Posts, 3-1/2" O.D., 18'6" Wide College Goal with 4' Offsets	1,186 lbs.	\$3,698	\$2,945
2228-00	Dual-Post Gooseneck Goal Posts, 4-1/2" O.D., 23'4" Wide High School Goal with 4' Offsets	1,350 lbs.	\$4,407	\$3,259
2228-01	Dual-Post Gooseneck Goal Posts, 4-1/2" O.D., 18'6" Wide College Goal with 4' Offsets	1,430 lbs.	\$4,407	\$3,165

BASEBALL ARCH BACKSTOPS

America's #1 Choice for the Original Arch Backstop Since 1919!



Model #1218-VP
\$10,513 Powder Coated Frame
Vinyl Coated Mesh

PERPENDICULAR ARCH BACKSTOPS

Perpendicular Arch Backstops

Model	Height	Width	Depth	Weight	Galvanized Frame Only	Powder Coat Frame Only	Galvanized Frame & Galv Mesh	Galvanized Frame & Vinyl Coat Mesh	Powder Coat Frame & Galv Mesh	PC Frame & Vinyl Coat Mesh
1214	14'6"	30'	14'6"	1,750 lbs.	\$4,063	\$5,163	\$6,063	\$7,263	\$7,273	\$8,473
1212	15'6"	40'	15'6"	2,250 lbs.	\$4,692	\$5,892	\$6,892	\$8,092	\$8,212	\$9,412
1218	14'6"	50'	14'6"	2,750 lbs.	\$5,693	\$6,893	\$7,993	\$9,193	\$9,313	\$10,513
1216	20'	62'	20'	4,000 lbs.	\$8,298	\$9,598	\$11,298	\$12,798	\$12,728	\$14,228

Add Choices to Model Number. Galvanized Frame Only (F), Galvanized Frame & Mesh (G), Powder Coated Frame Only (FP), Powder Coated Frame & Galvanized Mesh (GP), Powder Coated Frame & Vinyl Coated Mesh (VP). Examples: 1218-VP, 1212-F, 1214-FP, etc.



Model #1212-G
\$6,892 Galvanized Frame
Galvanized Mesh

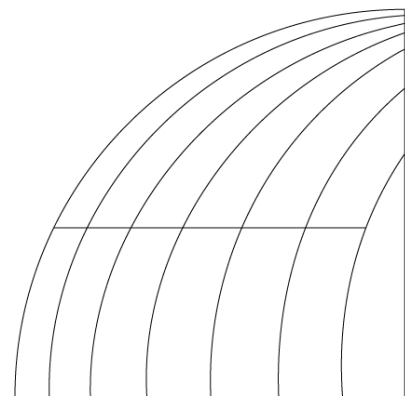

Profile Details for Perpendicular Models #1212, #1214, #1216 & #1218

Patterson-Williams pioneered the now famous "perpendicular" backstop, nationally recognized as the most effective design to control foul balls. No other backstop available comes close to the perfect combination of design, engineering, testing and manufacturing expertise.

A Hallmark of Patterson-Williams

BASEBALL ARCH BACKSTOPS



PERPENDICULAR ARCH BACKSTOPS WITH 5' OR 10' EXTENSION

Model #1218-05G
\$9,704 Galvanized Frame
and Mesh

Perpendicular Arch Backstop and 5' or 10' Front Cage Extension

Model	Height	Width	Depth	Weight	Galvanized Frame Only	Powder Coat Frame Only	Galvanized Frame & Galv Mesh	Galv Frame & Vinyl Coat Mesh	Powder Coat Frame & Galv Mesh	PC Frame & Vinyl Coat Mesh
1214-05	14'6"	30'	19'6"	2,450 lbs.	\$5,174	\$6,374	\$7,474	\$8,774	\$8,794	\$10,094
1214-10	14'6"	30'	24'6"	3,430 lbs.	\$6,305	\$7,605	\$8,905	\$10,305	\$10,335	\$11,735
1212-05	15'6"	40'	20'6"	3,050 lbs.	\$5,900	\$7,300	\$8,400	\$9,800	\$9,940	\$11,340
1212-10	15'6"	40'	25'6"	4,150 lbs.	\$7,518	\$9,018	\$10,318	\$11,918	\$11,968	\$13,568
1218-05	14'6"	50'	19'6"	3,850 lbs.	\$6,904	\$8,404	\$9,704	\$11,204	\$11,354	\$12,854
1218-10	14'6"	50'	24'6"	5,390 lbs.	\$8,519	\$10,119	\$11,619	\$13,319	\$13,379	\$15,079
1216-05	20'	62'	25'	5,375 lbs.	\$10,487	\$12,087	\$14,187	\$16,487	\$15,947	\$18,247
1216-10	20'	62'	30'	6,060 lbs.	\$10,747	\$12,447	\$15,147	\$18,247	\$17,017	\$20,117

Add Choices to Model Number. Galvanized Frame Only (F), Galvanized Frame & Mesh (G), Powder Coated Frame Only (FP), Powder Coated Frame & Galvanized Mesh (GP), Powder Coated Frame & Vinyl Coated Mesh (VP). Examples: 1218-05G, 1212-10VP, 1216-10FP, etc.

Powder Coat Colors

Arch Backstops come standard as galvanized steel and mesh

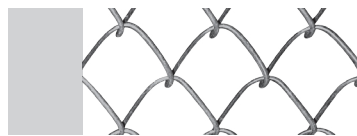

Galvanized (Standard)

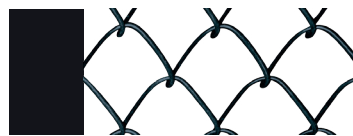

Black

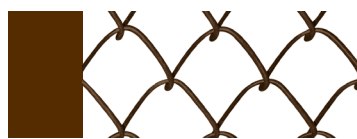

Brown

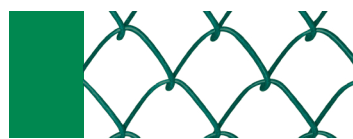

Hunter Green

BASEBALL ARCH BACKSTOPS

Model #1217G

\$6,792 Galvanized Frame and Mesh



LAYBACK ARCH BACKSTOPS

Layback Arch Backstops

Model	Height	Width	Depth	Weight	Galvanized Frame Only	Powder Coat Frame Only	Galvanized Frame & Galv Mesh	Galv Frame & Vinyl Coat Mesh	Powder Coat Frame & Galv Mesh	PC Frame & Vinyl Coat Mesh
1213	15'6"	40'	15'6"	1,700 lbs.	\$4,525	\$5,725	\$6,325	\$6,925	\$7,645	\$8,245
1217	14'6"	50'	14'6"	1,750 lbs.	\$4,992	\$6,092	\$6,792	\$7,792	\$8,002	\$9,002
1215	20'	62'	20'	2,250 lbs.	\$7,200	\$8,500	\$9,400	\$10,800	\$10,830	\$12,230

Add Choices to Model Number. Galvanized Frame Only (F), Galvanized Frame & Mesh (G), Powder Coated Frame Only (FP), Powder Coated Frame & Galvanized Mesh (GP), Powder Coated Frame & Vinyl Coated Mesh (VP). Examples: 1217-VP, 1215-F, 1213-FP, etc.



Model #1215G

\$9,400 Galvanized Frame and Mesh

Powder Coat Colors

Arch Backstops come standard as Galvanized steel and mesh

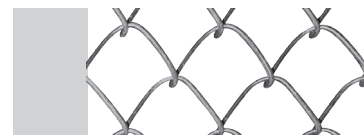

Galvanized (Standard)

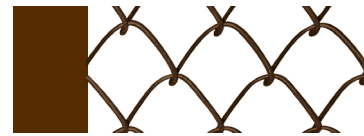

Brown

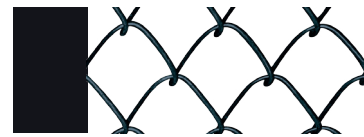

Black

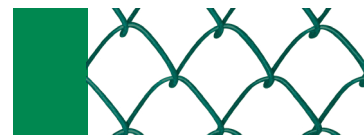

Hunter Green

Layback Models #1213, #1215, & #1217

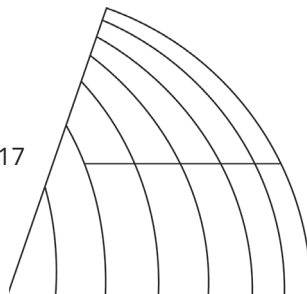



HEAVY-DUTY HOODED TRUSS BACKSTOP WITH PLANKING

Model #1246-55VP
\$32,182 Powder Coated Frame, Vinyl Coated Mesh

Our largest, conventional type, hooded backstop ideal for league use. This model comes in two sizes and provides excellent ball capture, permitting more freedom in the placement of playing fields. Manufactured from Heavy-Duty galvanized steel, with 4-1/2" O.D. vertical support post and 2-7/8" O.D. arched truss with 2-3/8" O.D. supports. Chain link mesh is 9-gauge on rear and side panels with 11-gauge on the hood. Planking is made from green 2" x 12" recycled plastic and is four high on the rear end two high on the sides.

Frame and mesh are available as galvanized or powder coat.
Vinyl mesh is available in our 3 colors at an additional price.

Heavy-Duty Hooded Truss Backstop with Planking

Model	Description	Vertical Pipe	Front Height	Front Width	Side Height	Side Width	Rear Height	Rear Width	Depth	Weight	Galvanized Frame & Mesh	Powder Coated Frame & Vinyl Coated Mesh
1246-55	51' with Hooded Truss	4-1/2" O.D.	20'	51' 2.5"	14' - 20'	23' 8"	14'	17' 8"	17'	4,700 lbs.	\$27,729	\$32,182
1246-43	60' with Hooded Truss	4-1/2" O.D.	20'	60'	12' - 20'	28'	12'	20'	20'	5,560 lbs.	\$30,746	\$35,970

Powder Coat Colors

Arch Backstops come standard as galvanized steel and mesh



Galvanized (Standard)



Black



Brown



Hunter Green

PERMANENT HOODED BACKSTOP



Model #1234-03G
\$6,240 Galvanized Finish

PW's full size models of our original traditional backstop are ideal for heavy-use school and university ball fields, as well as park districts.

Order Galvanized or Powder Coated Frames

Our Optional Green 2" x 12" reinforced, 100% recycled plastic planks are the best in the Industry!

Permanent Hooded Backstop 19'6" x 44' & 19'6" x 54'

Model	Description	Vertical Pipe	Front Height	Front Width	Side Height	Side Width	Rear Height	Rear Width	Depth	Weight	Galvanized Frame & Mesh	Galv Frame & VC Mesh	Powder Coated Frame & Galvanized Mesh	Powder Coated Frame & Vinyl Coated Mesh
1234-00	Hooded Backstop	2-7/8" O.D.	19'6"	44'	12'	10'	12'	30'	7'6"	2,050 lbs.	\$5,139	\$6,457	\$6,029	\$7,338
1234-02	Hooded with 2 Planks	2-7/8" O.D.	19'6"	44'	12'	10'	12'	30'	7'6"	2,330 lbs.	\$5,871	\$7,292	\$6,751	\$8,187
1234-03	Hooded with 3 Planks	2-7/8" O.D.	19'6"	44'	12'	10'	12'	30'	7'6"	2,470 lbs.	\$6,240	\$7,716	\$7,119	\$8,600
1235-00	Hooded Backstop	3-1/2" O.D.	19'6"	54'	12'	10'	12'	30'	7'6"	2,650 lbs.	\$6,308	\$7,885	\$7,342	\$8,918
1235-02	Hooded with 2 Planks	3-1/2" O.D.	19'6"	54'	12'	10'	12'	30'	7'6"	3,000 lbs.	\$7,040	\$8,720	\$8,073	\$9,793
1235-03	Hooded with 3 Planks	3-1/2" O.D.	19'6"	54'	12'	10'	12'	30'	7'6"	3,175 lbs.	\$7,410	\$9,144	\$8,466	\$10,155

Powder Coat Colors

Arch Backstops come standard as galvanized steel and mesh



Galvanized (Standard)



Black



Brown



Hunter Green

- Multiple width and height choices to address various levels of team play, spectator safety and property protection.

- Engineered for easy assembly and installation.

- All frames & mesh come standard as galvanized.

- All models available with or without 2" x 12" GREEN recycled plastic planking unless otherwise noted. – PW exclusive.

PERMANENT HOODED BACKSTOP REGULATION SERIES



Model #1230-00G
\$3,359 Galvanized Finish

The mid-sized model of our original traditional backstop is perfect for average-use ball fields. Comes standard as galvanized. Planking is available in standard Green 2" x 12" reinforced 100% recycled plastic planks.

Permanent Hooded Backstop 17'6" x 34' & 19'6" x 34'

Model	Description	Vertical Pipe	Front Height	Front Width	Side Height	Side Width	Rear Height	Rear Width	Depth	Weight	Galvanized Frame & Mesh	Galv Frame & VC Mesh	Powder Coated Frame & Galvanized Mesh	Powder Coated Frame & Vinyl Coated Mesh
1230-00	Hooded Backstop	2-3/8" O.D.	17'6"	34'	10'	10'	10'	20'	7'6"	1,475 lbs.	\$3,359	\$4,269	\$4,316	\$5,606
1230-02	Hooded with 2 Planks	2-3/8" O.D.	17'6"	34'	10'	10'	10'	20'	7'6"	1,615 lbs.	\$3,921	\$5,211	\$5,169	\$6,614
1230-03	Hooded with 3 Planks	2-3/8" O.D.	17'6"	34'	10'	10'	10'	20'	7'6"	1,685 lbs.	\$4,185	\$5,529	\$5,460	\$6,955
1233-00	Hooded Backstop	2-7/8" O.D.	19'6"	34'	12'	10'	12'	20'	7'6"	1,650 lbs.	\$3,990	\$5,462	\$5,397	\$7,071
1233-02	Hooded with 2 Planks	2-7/8" O.D.	19'6"	34'	12'	10'	12'	20'	7'6"	1,790 lbs.	\$4,758	\$6,399	\$6,000	\$7,715
1233-03	Hooded with 3 Planks	2-7/8" O.D.	19'6"	34'	12'	10'	12'	20'	7'6"	1,860 lbs.	\$5,024	\$6,490	\$6,169	\$8,061
1240-00	Hooded Backstop	3-1/2" O.D.	17'6"	34'	10'	10'	10'	20'	7'6"	1,800 lbs.	\$4,456	\$5,369	\$5,312	\$6,512
1240-02	Hooded with 2 Planks	3-1/2" O.D.	17'6"	34'	10'	10'	10'	20'	7'6"	1,940 lbs.	\$5,301	\$6,306	\$6,164	\$7,494
1240-03	Hooded with 3 Planks	3-1/2" O.D.	17'6"	34'	10'	10'	10'	20'	7'6"	2,010 lbs.	\$5,590	\$6,631	\$6,458	\$7,916

Powder Coat Colors

Arch Backstops come standard as galvanized steel and mesh

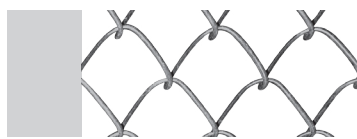

Galvanized (Standard)

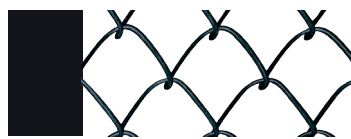

Black

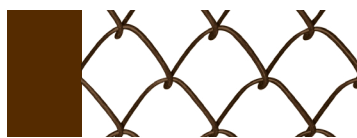

Brown

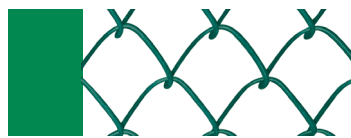

Hunter Green



Model #1228-00G
\$3,304 Galvanized Finish

PERMANENT HOODED BACKSTOP REGULATION SERIES

The smallest of our original traditional backstops delivers big PW value. Comes standard as galvanized. Planking is available in standard Green 2" x 12" reinforced 100% recycled plastic planks.

Permanent Hooded Backstop 17'6" x 24' Regulation Series

Model	Description	Vertical Pipe	Front Height	Front Width	Side Height	Side Width	Rear Height	Rear Width	Depth	Weight	Galvanized Frame & Mesh	Powder Coated Frame & Galvanized Mesh	Powder Coated Frame & Vinyl Coated Mesh
1228-00	Hooded Backstop	2-3/8" O.D.	17'6"	24'	10'	10'	10'	10'	7'6"	1,110 lbs.	\$3,304	\$4,137	\$4,518
1228-02	Hooded with 2 Planks	2-3/8" O.D.	17'6"	24'	10'	10'	10'	10'	7'6"	1,190 lbs.	\$3,742	\$4,578	\$4,967
1228-03	Hooded with 3 Planks	2-3/8" O.D.	17'6"	24'	10'	10'	10'	10'	7'6"	1,225 lbs.	\$4,007	\$4,983	\$5,364

Powder Coat Colors

Arch Backstops come standard as galvanized steel and mesh



Galvanized (Standard)



Black

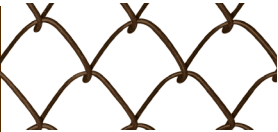

Brown



Hunter Green

- Multiple width and height choices to address various levels of team play, spectator safety and property protection.
- Engineered for easy assembly and installation.
- All frames & mesh come standard as galvanized.
- All models available with or without 2" x 12" GREEN recycled plastic planking unless otherwise noted. - PW exclusive.

BASEBALL & SOFTBALL BACKSTOPS



Model #1201-10G
\$1,836 Galvanized Finish

VALUE SERIES BACKSTOPS

Value Series Backstops 10' x 17'2"

Model	Description	Front Height	Front Width	Side Height	Side Width	Rear Height	Rear Width	Depth	Weight	Galvanized Frame & Mesh	Galvanized Frame & Vinyl Coated Mesh	Powder Coated Frame & Galvanized Mesh	Powder Coated Frame & Vinyl Coated Mesh
1201-10	Permanent Hooded	10'	17'2"	8'	7'6"	8'	7'6"	5'8"	640 lbs.	\$1,836	\$2,443	\$2,425	\$3,042
1202-10	Portable Hooded	10'	17'2"	8'	7'6"	8'	7'6"	5'8"	660 lbs.	\$1,969	\$2,606	\$2,497	\$3,118
1205-10	Permanent Non-Hooded	10'	17'2"	10'	7'6"	10'	7'6"	5'8"	530 lbs.	\$1,399	\$1,763	\$1,850	\$2,190
1206-10	Portable Non-Hooded	10'	17'2"	10'	7'6"	10'	7'6"	5'8"	560 lbs.	\$1,532	\$1,926	\$2,023	\$2,366

Powder Coat Colors

Arch Backstops come standard as Galvanized steel and mesh



Galvanized (Standard)

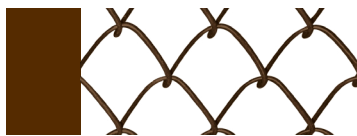

Brown

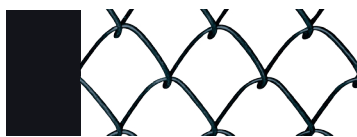

Black



Hunter Green

Our smaller style traditional economy backstop models are designed to deliver full PW value on a smaller budget. Made of 2-3/8" O.D. Galvanized steel support posts with 9 gauge steel mesh. Planking is not available on this model.

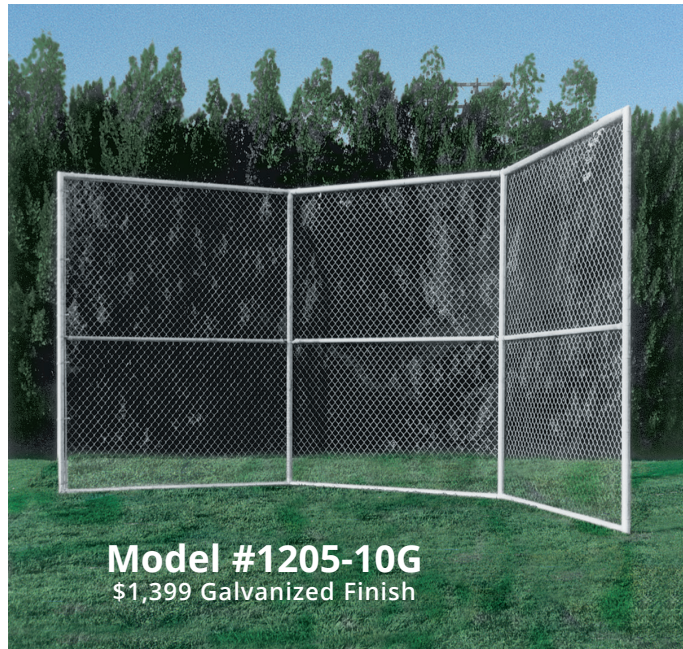

Model #1205-10G
\$1,399 Galvanized Finish



Model #1220C
\$4,528 without Privacy Fabric

FENCE POST DUGOUTS



Model #1220S
\$5,168 Bench Sold Separately

FENCE POST DUGOUT

Options include:

- 1) Metal roof with white 24"W panels
- 2) Fabric roof from Polytex fabric

With in-ground mount posts, rafters, and roofing.

Can be fitted to your H.D. fence posts.

Fence Post Dugouts

Model	Description	Posts	Price
1220C	8' x 24' x 8' Fabric Style	6 Posts	\$4,528
1220S	8' x 24' x 8' Metal Style	6 Posts	\$5,168
1220CR	8' x 24' Rafters & Fabric Roof	No Posts	\$1,769
1220SR	8' x 24' Rafters & Metal Roof	No Posts	\$2,410
1229	Privacy Fabric 4' Tall with Eyelets, Green, 50 Yards	No Posts	\$268

Colors

Natural



Midnight Green

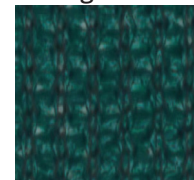

Polytex fabric with a high density polyethylene monofilament and tape construction. Knitted together utilizing a lock stitch construction to ensure against tears or fraying if cut or pierced by sharp objects. Provides more than 95% protection from UVA and UVB rays. Flame retardant - California State Fire Marshal 13115, NFPA 01-1999, ASTM_E-84, Class A building material.



BATTING TUNNELS

Made of galvanized steel, we offer in ground or portable batting cages. These are constructed of 2-3/8" O.D. tubing and come in the two most popular sizes, 12' X 14' X 55', and 12' X 14' X 70'. These are made to be the easiest to install and durable for years of service. Nets are constructed of high durability strand with UV protection. Video install is available to see how easy this new product is to use and install.

Batting Tunnels

Model	Description	Powder Coated Frame	Galvanized Frame
1295-55M1	14' x 55' Batting Tunnel with Netting, Permanent	\$3,236	\$2,952
1295-55M2	14' x 55' Batting Tunnel with Netting, Portable	\$3,690	\$3,406
1295-70M1	14' x 70' Batting Tunnel with Netting, Permanent	\$3,605	\$3,321
1295-70M2	14' x 70' Batting Tunnel with Netting, Portable	\$4,059	\$3,775

Model #1295-55M2
\$3,690 Powder Coated Finish



COLLEGIATE PITCHERS PROTECTOR

Portable Collegiate Pitchers Protector fabricated with 1-5/8" Steel tubing and steel mesh.

Model #1290-00
\$340 Galvanized Finish

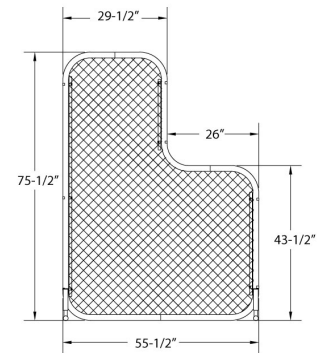

Collegiate Pitchers Protector

Model	Description	Weight	Powder Coat Frame & Galv Mesh	Galvanized Frame & Mesh
1290-00	Pitchers Protector	55 lbs.	\$382	\$340

SIDELINE FENCING

Manufactured from 2-3/8" O.D. steel posts, the 11-gauge mesh attaches with tension bars and brace bands. Available in 10' wide panels which can be extended in 10' increments. Comes galvanized as standard. Sold as pairs.

Model #1261-08G
\$536 Galvanized Finish



Sideline Fencing

Model	Description	Weight	Powder Coat Frame & Galv Mesh	Galvanized Frame & Mesh
1261-06	6' H x 10' W Sideline Fencing	250 lbs.	\$479	\$422
1261-08	8' H x 10' W Sideline Fencing	280 lbs.	\$592	\$536

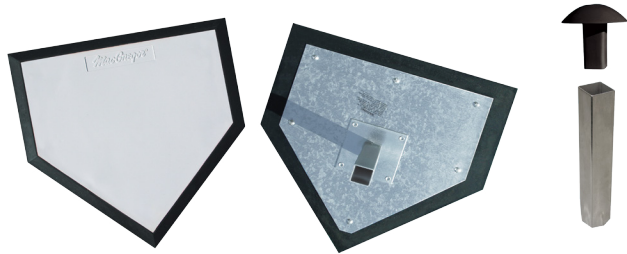

Model #8500-00 Home Plate with Anchor, white rubber with beveled edge includes plate anchor.

MAJOR LEAGUE BASEBALL BASES



Model #8504-00 Dislodging Safety Base



The dislodging base is designed to reduce the potential for injuries sustained through sliding. On impact the top pad dislodges from the base plate. The pad can be reset on the plate in seconds.



Model #8501-00 Professional Style Home Plate.



Model #8502-02 Ground Anchor Replacement Plugs



Model #8510-00 4-Way Pitching Rubber



Model #8503-00 Complete Set of 3 Bases, Heavy-Duty white rubber, includes ground anchors.



PORTABLE OUTFIELD FENCE PANELS



Portable outfield panels are designed to increase the versatility of recreational baseball facilities. Panels come pre-assembled and can be moved easily to accommodate all age groups and leagues. Manufactured from 1-3/8" O.D. Galvanized steel, the 11-gauge mesh attaches with tension bars and brace bands. Available in 4' High x 10' wide panels which can be purchased in 10' increments. Comes galvanized as standard. Poly-Cap protective fence guard available for install over your chain link fence which adds safety and visibility to your field. Available in Bright Yellow or Green. Comes in 100' and 250' lengths.

Portable Outfield Fence Panels

Model	Description	Weight	Price
1270-00G	4' H x 10' W Outfield Fence Panels (Galvanized)	98 lbs.	\$269
1270-00P	4' H x 10' W Outfield Fence Panels (Powder Coated)	98 lbs.	\$592
1270-10	100' Poly-Cap Protective Guard	40 lbs.	\$256
1270-25	250' Poly-Cap Protective Guard	90 lbs.	\$340
1270-15	Nylon Ties to attach Poly-Cap Guards (Set of 100)	2 lbs.	\$104

Major League Baseball Bases

Model	Description	Weight	Price
8500-00	Home Plate with Anchor	24 lbs.	\$156
8501-00	Professional Style Home Plate (Bury Mount)	25 lbs.	\$156
8502-01	Ground Anchors (Set of 3)	3 lbs.	\$58
8502-02	Replacement Plugs for Ground Anchors (Set of 3)	3 lbs.	\$58
8503-00	Complete Set of 3 Bases (Includes Anchors)	48 lbs.	\$275
8510-00	4-Way Pitching Rubber (Bury Mount)	30 lbs.	\$176
8504-00	Dislodging Safety Base (Set of 3)	56 lbs.	\$314

BAT RACKS



All welded construction. Bat holders are manufactured of 4-1/2" O.D. Aluminum with 2" O.D. Aluminum support posts. Comes standard as in-ground mount. Powder coat colors on page 2.

Bat Racks

Model	Description	Weight	Powder Coated Price	Galvanized Price
1280-08	Bat Holder for 8 Bats	69 lbs.	\$478	\$406
1280-15	Bat Holder for 15 Bats	83 lbs.	\$799	\$711

VALUE SERIES FOUL BALL POLES

Foul ball poles manufactured from one piece 3-1/2" O.D. Heavy-duty galvanized steel. Flag is manufactured from 2-1/2" square galvanized steel tube with mitered corners and diamond steel mesh. Surface mount option available. Standard finish is powder coated yellow.



Model #1267
\$958 per pair

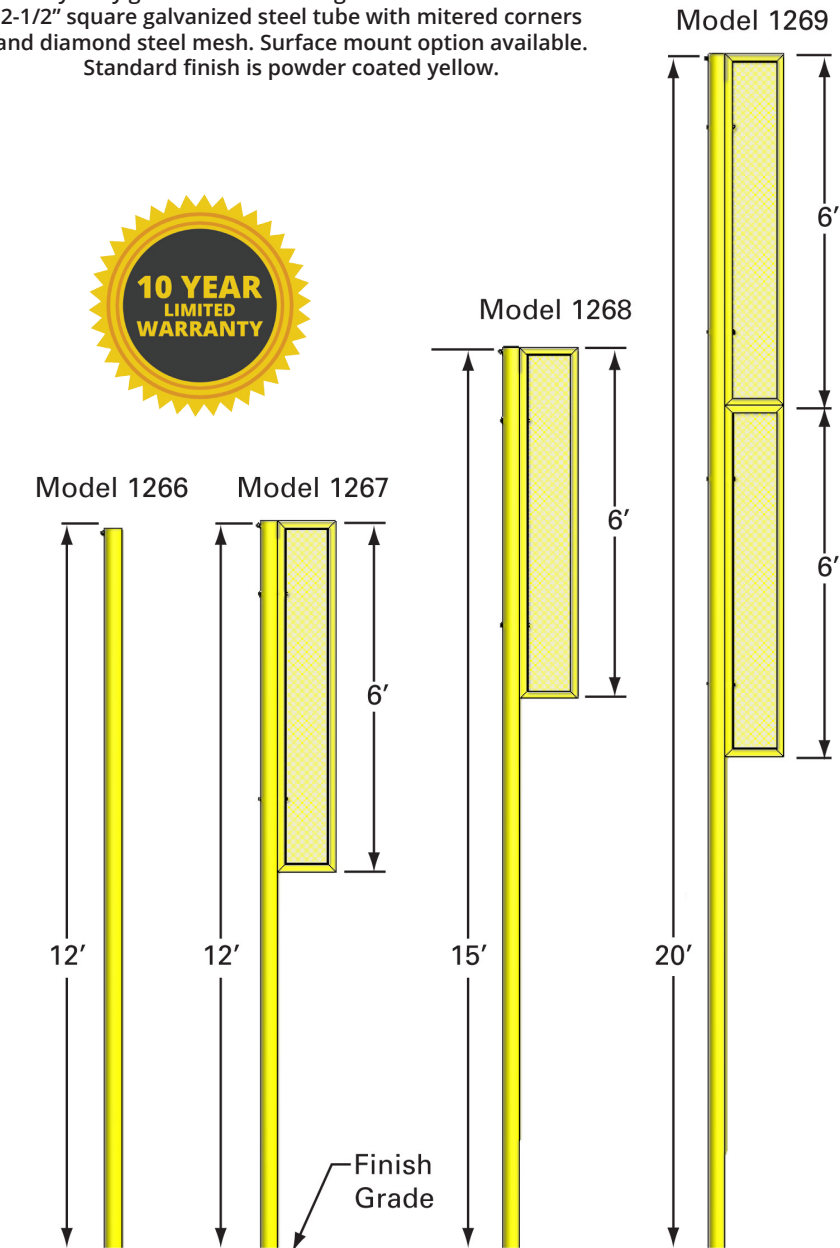

Value Series Foul Ball Poles

Model	Number of Posts	Post Size	Flag Size	Height	Weight	Powder Coat Price
1266	2	3-1/2" O.D. Post	N/A	12'	130 lbs.	\$698
1267	2	3-1/2" O.D. Post	12" x 6'	12'	185 lbs.	\$958
1268	2	3-1/2" O.D. Post	12" x 6'	15'	210 lbs.	\$1,187
1269	2	3-1/2" O.D. Post	(2) 12" x 6'	20'	320 lbs.	\$1,283
1200-VSM	N/A	Surface Mount Option	N/A	N/A	160 lbs.	\$440
8376-03	N/A	Post Pad for round posts up to 3-1/2"OD	N/A	N/A	10 lbs.	\$460

PRO SERIES FOUL BALL POLES

To ensure our foul ball poles meet all critical specifications, we factory-assemble all components before shipping. Flag is manufactured from heavy duty galvanized 2-3/8" O.D. steel pipe and steel mesh. Standard finish is powder coated yellow.

Pro Series Foul Ball Poles

Model	Number of Posts	Post Size	Flag Size	Height	Weight	Powder Coat Price
1271	2	3-1/2" O.D. Post	N/A	20'	210 lbs.	\$1,389
1273	2	3-1/2" O.D. Post	1.5' x 12' Mesh	20'	340 lbs.	\$2,506
1272	2	4-1/2" O.D. Post	1.5' x 12' Mesh	20'	360 lbs.	\$2,611
1274	2	4-1/2" O.D. Post	1.5' x 22' Mesh	30'	540 lbs.	\$3,533
1275	2	5-9/16" O.D. Post	1.5' x 32' Mesh	40'	745 lbs.	\$4,230
SMP	N/A	Surface Mount Option	N/A	N/A	41 lbs.	\$490
8376-03	N/A	Post Pad for round posts up to 3-1/2"OD	N/A	N/A	10 lbs.	\$460
8376-04	N/A	Post Pad for round posts up to 4-1/2"OD	N/A	N/A	12 lbs.	\$464
8376-05	N/A	Post Pad for round posts up to 5-9/16"OD	N/A	N/A	15 lbs.	\$520

Model #1275

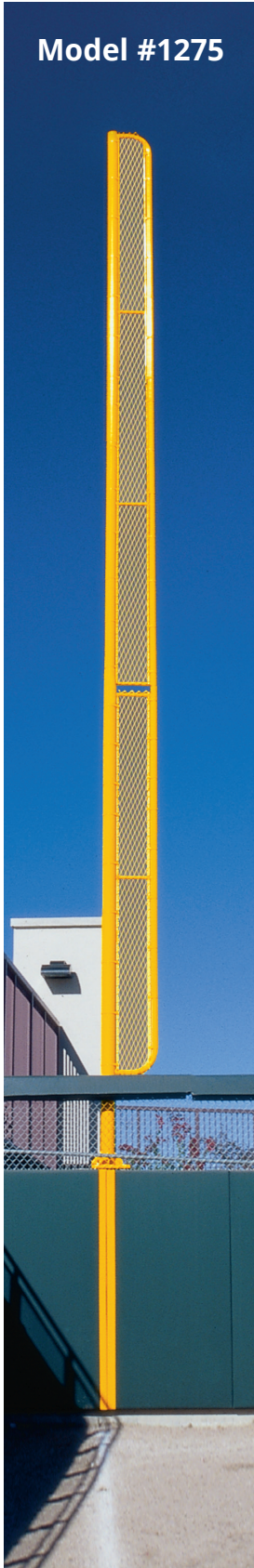

Model #1274

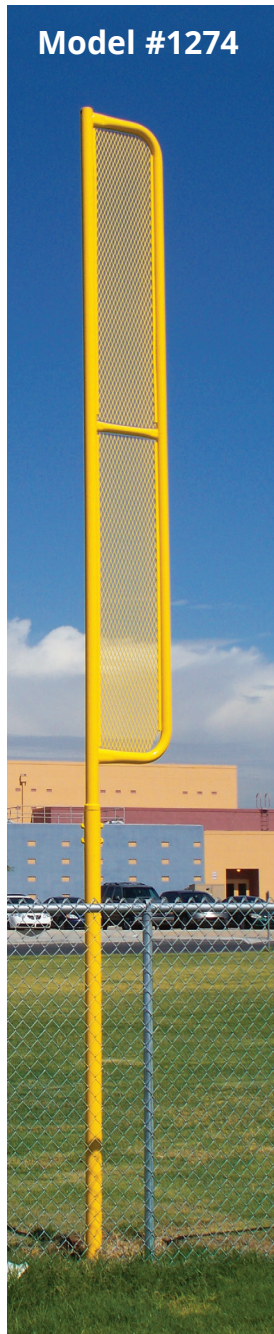

Surface Mount Option
add \$490 per pair



Model #1273



Model #1271



TIP & ROLL BLEACHERS

TIP & ROLL BLEACHERS WITH 8" RISE

Model #1171-315TRA
\$1,701 Aluminum Frame

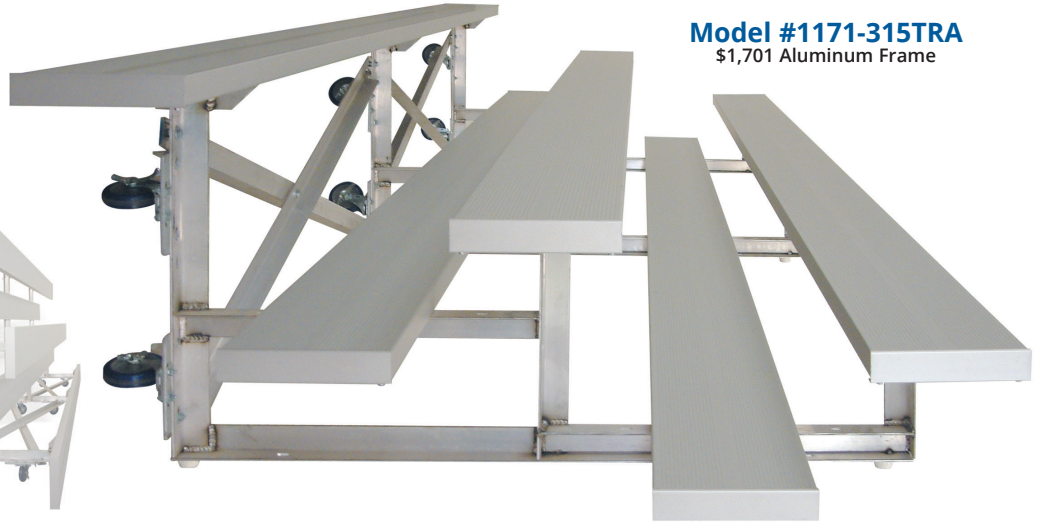

WARNING: Tip and Roll Bleachers should only be used INDOORS and require a capable adult to tip and move into position. Larger units may require two adults.

These bleachers come with 2" x 10" anodized aluminum seats. Our Tip and Roll Bleachers are equipped with caster wheels and foot pads that won't mar or scratch wood floors. Powder coat colors page 2.

Tip & Roll Bleachers

Model	Description	Seating Capacity	Weight	Powder Coat Frame	Unfinished Frame
1171-315TRA	3-Row 15' Aluminum Frame Tip & Roll	30	240 lbs.	\$1,896	\$1,701
1171-315TRG	3-Row 15' Galv Steel Frame Tip & Roll	30	265 lbs.	\$1,969	\$1,777
1171-321TRA	3-Row 21' Aluminum Frame Tip & Roll	42	343 lbs.	\$2,551	\$2,289
1171-321TRG	3-Row 15' Galv Steel Frame Tip & Roll	42	375 lbs.	\$2,611	\$2,355
1171-415TRA	4-Row 15' Aluminum Frame Tip & Roll	40	368 lbs.	\$2,497	\$2,284
1171-415TRG	4-Row 15' Galv Steel Frame Tip & Roll	40	493 lbs.	\$2,559	\$2,349
1171-421TRA	4-Row 21' Aluminum Frame Tip & Roll	52	476 lbs.	\$3,270	\$3,010
1171-421TRG	4-Row 21' Galv Steel Frame Tip & Roll	52	667 lbs.	\$3,319	\$3,083
Upcharge to Powder Coat 10" Aluminum Planks				\$7.00 per ft.	

(Add -P to model # for powder coated frame)

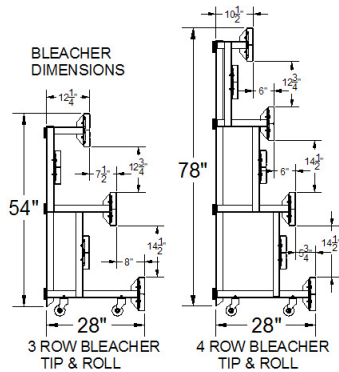

ALUMINUM REPLACEMENT PLANKING & SEATING COMPONENTS

We offer our extra heavy-duty 2" x 10" or 2" x 12" anodized aluminum planks and hardware to be purchased individually to meet your design requirements. Standard stock lengths are 15 ft., 21 ft., 24 ft. and 27 ft. Our surface mount stadium frames with back are made from 2-3/8" O.D. Galvanized steel. The 'Z' bracket frame without back is made from 3/16" galvanized steel. Frames come standard as Galvanized or Powder Coated. Powder coat colors page 2.

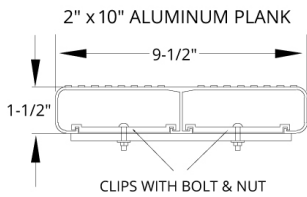

Model #A210
Aluminum Plank and ACLP Clip

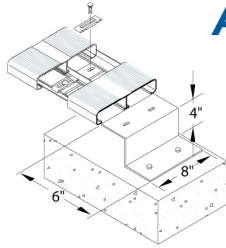

Model #1119Z-S
Stadium Bench "Z" Bracket without Back

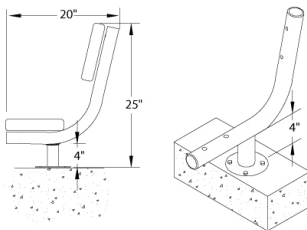

Model #1103F-S
Stadium Bench Frame with Back

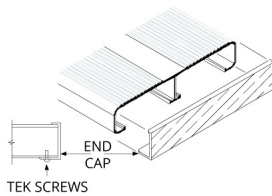

Model #AECF=10
End Cap

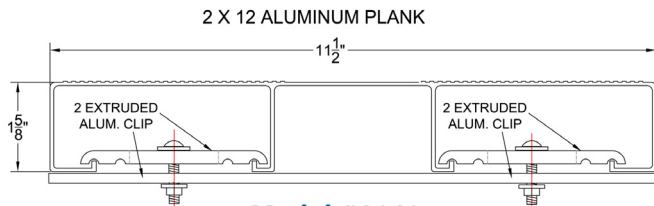

Model #A212
Aluminum Plank and ACLP Clip

Replacement Planking & Seating Components

Model	Description	Weight	Price
A210	2" x 10" Anodized Aluminum Plank	1.8 lbs. per ft.	\$13 per ft.
A212	2" x 12" Anodized Aluminum Plank	2.4 lbs.	\$17 per ft.
AECF-10	2" x 10" Aluminum End Cap with Tek Screws	0.25 lbs.	\$4.00 each
AECF-12	2" x 12" Aluminum End Cap with Tek Screws	0.25 lbs.	\$4.00 each
ACLP	Aluminum Attached Clips with Hardware	0.25 lbs.	\$4.00 each

ALUMINUM SEATING

3 & 4 ROW STANDARD BLEACHERS



Model #1171-315A
\$1,538 Powder Coated Frame

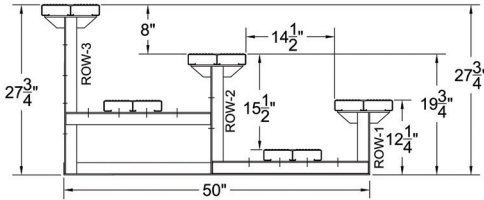

3-ROW STANDARD BLEACHERS WITH 8" RISE

These bleachers come with 2" x 10" anodized aluminum seat boards. Available in aluminum or galvanized frame. Optional ground sills made of 2" x 6" pressure treated wood and sized according to length of frame. Powder coat colors page 2.

3-Row Standard Bleachers

Model	Description	Seating Capacity	Weight	Powder Coat Frame	Unfinished Frame
1171-315A	3-Row 15' Aluminum Frame without Guardrails	30	235 lbs.	\$1,538	\$1,342
1171-315G	3-Row 15' Galv Steel Frame without Guardrails	30	260 lbs.	\$1,618	\$1,425
1171-321A	3-Row 21' Aluminum Frame without Guardrails	42	338 lbs.	\$2,027	\$1,766
1171-321G	3-Row 21' Galv Steel Frame without Guardrails	42	370 lbs.	\$2,097	\$1,841
1171-327A	3-Row 27' Aluminum Frame without Guardrails	66	441 lbs.	\$2,551	\$2,224
1171-327G	3-Row 27' Galv Steel Frame without Guardrails	66	480 lbs.	\$2,611	\$2,291
BTS	Bleacher Transport System with 2 Wheels & Hitch Assembly	N/A	140 lbs.	N/A	\$1,188
GS315	2" x 6" Ground Sills (Set of 3 for 15' Bleacher)	N/A	60 lbs.	N/A	\$86
GS321	2" x 6" Ground Sills (Set of 4 for 21' Bleacher)	N/A	80 lbs.	N/A	\$114
GS327	2" x 6" Ground Sills (Set of 5 for 27' Bleacher)	N/A	100 lbs.	N/A	\$125
Upcharge to Powder Coat 10" Aluminum Planks				\$7.00 per ft.	

(Add -P to model # for powder coated frame)



Model #1171-415A
\$1,896 Aluminum Frame

4-ROW STANDARD BLEACHERS WITH 6" RISE

These bleachers come with 2" x 10" anodized aluminum seats. Available in aluminum or galvanized frame. Optional ground sills made of 2" x 6" pressure treated wood and sized according to length of frame. Powder coat colors page 2.

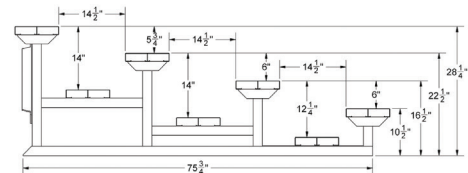

4-Row Standard Bleachers

Model	Description	Seating Capacity	Weight	Powder Coat Frame	Unfinished Frame
1171-415A	4-Row 15' Aluminum Frame without Guardrails	40	318 lbs.	\$2,093	\$1,896
1171-415G	4-Row 15' Galv Steel Frame without Guardrails	40	443 lbs.	\$2,162	\$1,970
1171-421A	4-Row 21' Aluminum Frame without Guardrails	52	426 lbs.	\$2,748	\$2,486
1171-421G	4-Row 21' Galv Steel Frame without Guardrails	52	617 lbs.	\$2,805	\$2,548
1171-427A	4-Row 27' Aluminum Frame without Guardrails	76	534 lbs.	\$3,466	\$3,139
1171-427G	4-Row 27' Galv Steel Frame without Guardrails	76	787 lbs.	\$3,511	\$3,190
BTS	Bleacher Transport System with 2 Wheels & Hitch Assembly	N/A	140 lbs.	N/A	\$1,188
GS415	2" x 6" Ground Sills (Set of 3 for 15' Bleacher)	N/A	60 lbs.	N/A	\$103
GS421	2" x 6" Ground Sills (Set of 4 for 21' Bleacher)	N/A	80 lbs.	N/A	\$137
GS427	2" x 6" Ground Sills (Set of 5 for 27' Bleacher)	N/A	100 lbs.	N/A	\$171
Upcharge to Powder Coat 10" Aluminum Planks				\$7.00 per ft.	

(Add -P to model # for powder coated frame)

5 ROW STANDARD BLEACHERS

5-ROW STANDARD BLEACHERS WITH 8" RISE



Model #1171-521MESHA
\$4,600 Aluminum Frame

- Double foot-boards and risers on rows 4 and 5 for added safety.
- Your choice of vertical bar or mesh guard rails.
- Your choice of Aluminum or Hot Dip Galvanized Frames, made in the U.S.A.
- First row has a seat height of 12".
- Top row has a seat height of 43".
- Planks are 10"W
- Seat planks are anodized aluminum for added protection against black streaks to your clothes.

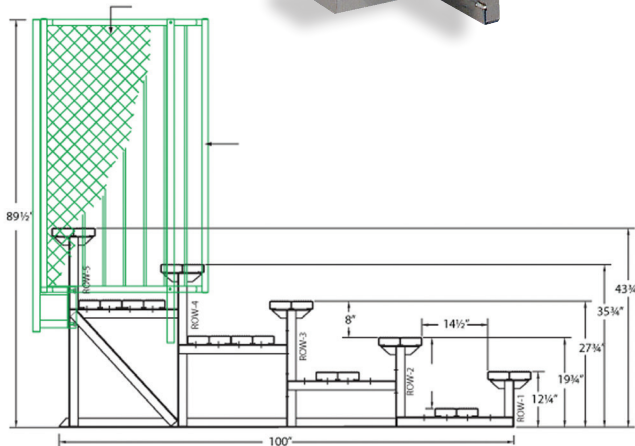

STANDARD 5-ROW BLEACHER DIMENSIONS

CAUTION
BLEACHERS CAN TIP OVER
Anchoring System is recommended

When ordering bleachers, we advise that you check your local requirements for aisles, guardrails, ADA, or other items. Building codes may vary by year written and by group who issues them.

5-Row Standard Bleachers

Model	Description	Seating Capacity	Weight	Powder Coat Frame	Unfinished Frame
1171-515MESHA	5-Row 15' Aluminum Frame with pre-assembled Mesh Guardrails	50	810 lbs.	\$3,488	\$3,336
1171-515MESHG	5-Row 15' Galv Steel Frame with pre-assembled Mesh Guardrails	50	900 lbs.	\$4,078	\$3,907
1171-515VBGRA	5-Row 15' Aluminum Frame with pre-assembled Vertical Bar Guardrails	50	910 lbs.	\$3,892	\$3,741
1171-515VBGRG	5-Row 15' Galv Steel Frame with pre-assembled Vertical Bar Guardrails	50	950 lbs.	\$4,538	\$4,366
1171-521MESHA	5-Row 21' Aluminum Frame with pre-assembled Mesh Guardrails	70	855 lbs.	\$4,803	\$4,600
1171-521MESHG	5-Row 21' Galv Steel Frame with pre-assembled Mesh Guardrails	70	1,080 lbs.	\$5,630	\$5,400
1171-521VBGRA	5-Row 21' Aluminum Frame with pre-assembled Vertical Bar Guardrails	70	1,050 lbs.	\$5,258	\$5,056
1171-521VBGRG	5-Row 21' Galv Steel Frame with pre-assembled Vertical Bar Guardrails	70	1,195 lbs.	\$6,147	\$5,917
1171-527MESHA	5-Row 27' Aluminum Frame with pre-assembled Mesh Guardrails	90	1,525 lbs.	\$5,662	\$5,409
1171-527MESHG	5-Row 27' Galv Steel Frame with pre-assembled Mesh Guardrails	90	1,600 lbs.	\$6,606	\$6,319
1171-527VBGRA	5-Row 27' Aluminum Frame with pre-assembled Vertical Bar Guardrails	90	1,720 lbs.	\$6,218	\$5,965
1171-527VBGRG	5-Row 27' Galv Steel Frame with pre-assembled Vertical Bar Guardrails	90	1,950 lbs.	\$7,181	\$6,894
1171-521HR	Add for 48" Aisle & Handrail	N/A	125 lbs.	N/A	\$946
1171-HR	Handrail for 5 Row Bleacher	N/A	N/A	\$213	\$194
1171-ADA	Bleacher ADA Option for Corner Cut Outs and Safety Railing	N/A	N/A	\$475	\$425
BTS	Bleacher Transport System with 2 Wheels and Hitch Assembly	N/A	140 lbs.	N/A	\$1,188
GS515	2" x 6" Ground Sills (Set of 3 for 15' Bleacher)	N/A	60 lbs.	N/A	\$120
GS521	2" x 6" Ground Sills (Set of 4 for 21' Bleacher)	N/A	80lbs.	N/A	\$160
GS527	2" x 6" Ground Sills (Set of 5 for 27' Bleacher)	N/A	100 lbs.	N/A	\$200
Upcharge to Powder Coat 10" Aluminum Planks				\$7.00 per ft.	

(Add -P to model # for powder coated frame)

3 & 4 ROW DELUXE BLEACHERS

3-ROW DELUXE BLEACHERS WITH 6" RISE

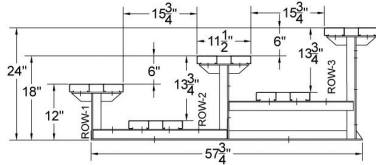

Model #1183-315A
\$1,489 Aluminum Frame

Our Deluxe Series Bleachers are designed for dependability and trouble-free maintenance. Featuring 2" x 12" anodized aluminum seats with 6" rise from row to row. Available in either aluminum or galvanized steel frames. Optional 2" x 6" ground sills available.

3-Row Deluxe Bleachers

Model	Description	Seating Capacity	Weight	Powder Coat Frame	Unfinished Frame
1183-315A	3-Row 15' Aluminum Frame without Guardrails	30	240 lbs.	\$1,682	\$1,489
1183-315G	3-Row 15' Galv Steel Frame without Guardrails	30	260 lbs.	\$1,790	\$1,597
1183-321A	3-Row 21' Aluminum Frame without Guardrails	42	343 lbs.	\$2,312	\$2,055
1183-321G	3-Row 21' Galv Steel Frame without Guardrails	42	363 lbs.	\$2,419	\$2,162
1183-327A	3-Row 27' Aluminum Frame without Guardrails	66	441 lbs.	\$2,743	\$2,422
1183-327G	3-Row 27' Galv Steel Frame without Guardrails	66	461 lbs.	\$2,851	\$2,529
BTS	Bleacher Transport System with 2 Wheels & Hitch Assembly	N/A	140 lbs.	N/A	\$1,188
GS315	2" x 6" Ground Sills (Set of 3 for 15' Bleacher)	N/A	60 lbs.	N/A	\$86
GS321	2" x 6" Ground Sills (Set of 4 for 21' Bleacher)	N/A	80lbs.	N/A	\$114
GS327	2" x 6" Ground Sills (Set of 5 for 27' Bleacher)	N/A	100 lbs.	N/A	\$125
Upcharge to Powder Coat 12" Aluminum Planks				\$8.00 per ft.	

(Add -P to model # for powder coated frame)

4-ROW DELUXE BLEACHERS WITH 6" RISE

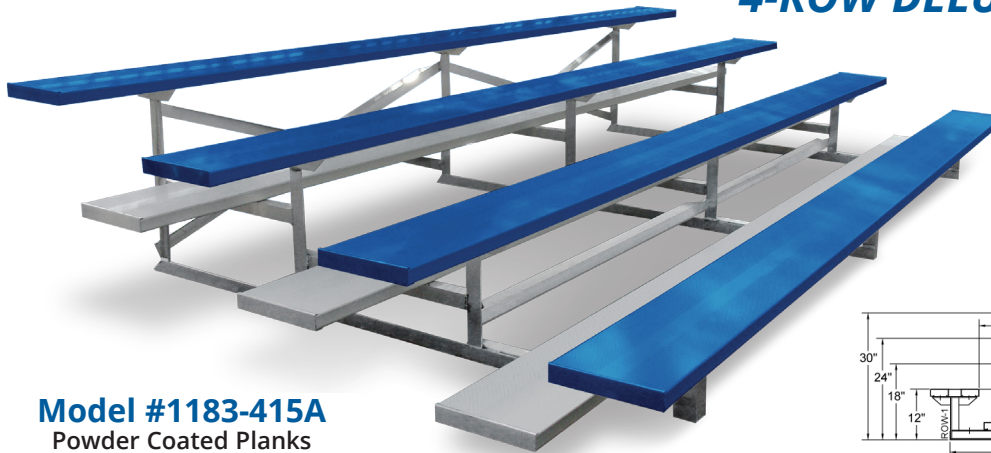

Model #1183-415A
Powder Coated Planks

CAUTION

BLEACHERS CAN TIP OVER
Anchoring System is recommended

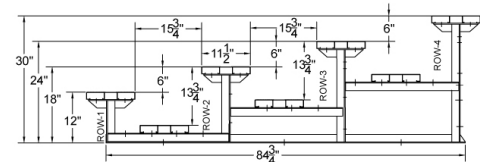

4-Row Deluxe Bleachers

Model	Description	Seating Capacity	Weight	Powder Coat Frame	Unfinished Frame
1183-415A	4-Row 15' Aluminum Frame without Guardrails	40	368 lbs.	\$2,210	\$2,016
1183-415G	4-Row 15' Galv Steel Frame without Guardrails	40	388 lbs.	\$2,318	\$2,124
1183-421A	4-Row 21' Aluminum Frame without Guardrails	52	476 lbs.	\$2,826	\$2,569
1183-421G	4-Row 21' Galv Steel Frame without Guardrails	52	496 lbs.	\$2,933	\$2,676
1183-427A	4-Row 27' Aluminum Frame without Guardrails	76	787 lbs.	\$3,596	\$3,276
1183-427G	4-Row 27' Galv Steel Frame without Guardrails	76	807 lbs.	\$3,790	\$3,468
BTS	Bleacher Transport System with 2 Wheels & Hitch Assembly	N/A	140 lbs.	N/A	\$1,188
GS415	2" x 6" Ground Sills (Set of 3 for 15' Bleacher)	N/A	60 lbs.	N/A	\$103
GS421	2" x 6" Ground Sills (Set of 4 for 21' Bleacher)	N/A	80lbs.	N/A	\$137
GS427	2" x 6" Ground Sills (Set of 5 for 27' Bleacher)	N/A	100 lbs.	N/A	\$171
Upcharge to Powder Coat 12" Aluminum Planks				\$8.00 per ft.	

(Add -P to model # for powder coated frame)

5 ROW DELUXE BLEACHERS

5-ROW DELUXE BLEACHERS WITH 6" RISE



Model #1183-515VBGRA

\$4,432 with Optional Handrail + (\$194)

- Double foot-boards and risers on rows 4 and 5 for added safety.
- Your choice of vertical bar or mesh guard rails.
- Your choice of Aluminum or Hot Dip Galvanized Frames, made in the U.S.A.
- First row has a seat height of 12".
- Top row has a seat height of 36".
- Planks are 12"W
- Seat planks are anodized aluminum for added protection against black streaks to your clothes.
- Optional 48" aisle and railing available.

When ordering bleachers, we advise that you check your local requirements for aisles, guardrails, ADA, or other items. Building codes may vary by year written and by group who issues them.

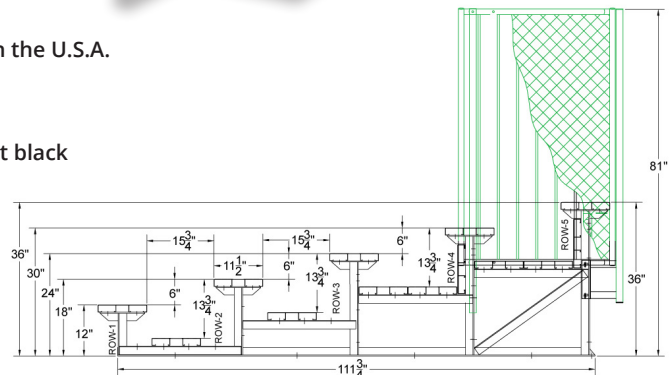

5-Row Deluxe Bleachers

Model	Description	Seating Capacity	Weight	Powder Coat Frame	Unfinished Frame
1183-515MESH	5-Row 15' Aluminum Frame with pre-assembled Mesh Guardrails	50	880 lbs.	\$4,303	\$4,110
1183-515MESHG	5-Row 15' Galv Steel Frame with pre-assembled Mesh Guardrails	50	990 lbs.	\$5,036	\$4,817
1183-515VBGRA	5-Row 15' Aluminum Frame with pre-assembled Vertical Bar Guardrails	50	995 lbs.	\$4,625	\$4,432
1183-515VBGRG	5-Row 15' Galv Steel Frame with pre-assembled Vertical Bar Guardrails	50	1,095 lbs.	\$5,401	\$5,182
1183-521MESH	5-Row 21' Aluminum Frame with pre-assembled Mesh Guardrails	62	1,055 lbs.	\$5,910	\$5,653
1183-521MESHG	5-Row 21' Galv Steel Frame with pre-assembled Mesh Guardrails	62	1,160 lbs.	\$6,715	\$6,423
1183-521VBGRA	5-Row 21' Aluminum Frame with pre-assembled Vertical Bar Guardrails	62	1,160 lbs.	\$6,681	\$6,424
1183-521VBGRG	5-Row 21' Galv Steel Frame with pre-assembled Vertical Bar Guardrails	62	1,280 lbs.	\$7,591	\$7,300
1183-527MESH	5-Row 27' Aluminum Frame with pre-assembled Mesh Guardrails	86	1,275 lbs.	\$7,451	\$7,130
1183-527MESHG	5-Row 27' Galv Steel Frame with pre-assembled Mesh Guardrails	86	1,390 lbs.	\$8,759	\$8,394
1183-527VBGRA	5-Row 27' Aluminum Frame with pre-assembled Vertical Bar Guardrails	86	1,380 lbs.	\$7,258	\$6,937
1183-527VBGRG	5-Row 27' Galv Steel Frame with pre-assembled Vertical Bar Guardrails	86	1,510 lbs.	\$8,394	\$8,029
1183-ADA	ADA Option for Corner Cut Outs and Safety Railing	N/A	N/A	\$475	\$425
1183-HR	Handrail for 5 Row Bleacher	N/A	N/A	\$213	\$194
GS515	2" x 6" Ground Sills (Set of 3 for 15' Bleacher)	N/A	60 lbs.	N/A	\$120
GS521	2" x 6" Ground Sills (Set of 4 for 21' Bleacher)	N/A	80 lbs.	N/A	\$160
GS527	2" x 6" Ground Sills (Set of 5 for 27' Bleacher)	N/A	100 lbs.	N/A	\$200
Upcharge to Powder Coat 12" Aluminum Planks				\$8.00 per ft.	

(Add -P to model # for powder coated frame)

DELUXE SERIES OUTDOOR BLEACHERS

Our Deluxe Series Bleachers are designed for dependability and trouble-free maintenance.
 Featuring 2" x 12" anodized aluminum seats with 6" rise from row to row.
 Available in either aluminum or galvanized steel frames. Optional 2" x 6" ground sills available.



- Includes center 48" aisle and hand rail.
- Double foot-boards and risers on rows 2-5 for added safety.
- Your choice of vertical bar or mesh guard rails.
- Your choice of Aluminum or Hot Dip Galvanized Frames, made in the U.S.A.
- First row has a seat height of 12".
- Top row has a seat height of 36".
- Planks are 12".
- Seat planks are anodized aluminum for added protection against black streaks to your clothes.
- Two styles of ADA cut-outs available.

Model #1186-521VBGRA
 Aluminum Frame
 & Powder Coated Planks

5-ROW 21' DELUXE BLEACHERS WITH 6" RISE

5-Row 21' Deluxe Bleachers

Model	Description	Seating Capacity	Weight	Powder Coat Frame	Unfinished Frame
1186-521MESH	5-Row 21' Aluminum Frame with pre-assembled Mesh Guardrails	52	1,280 lbs.	\$7,065	\$6,774
1186-521MESHG	5-Row 21' Galv Steel Frame with pre-assembled Mesh Guardrails	52	1,300 lbs.	\$8,978	\$8,613
1186-521VBGRA	5-Row 21' Aluminum Frame with pre-assembled Vertical Bar Guardrails	52	1,395 lbs.	\$7,357	\$7,065
1186-521VBGRG	5-Row 21' Galv Steel Frame with pre-assembled Vertical Bar Guardrails	52	1,450 lbs.	\$9,343	\$8,978
1186-ADA-1	ADA Option with Center Aisle and Corner ADA Cutout	N/A	N/A	\$475	\$425
1186-ADA-2	ADA Option with Side Aisle and Offset Center ADA Cutout	N/A	N/A	\$625	\$550
GS521	2" x 6" Ground Sills (Set of 4 for 21' Bleacher)	N/A	80 lbs.	N/A	\$160
Upcharge to Powder Coat 12" Aluminum Planks				\$8.00 per ft.	

(Add -P to model # for powder coated frame)

1186-ADA-1 Option Top View

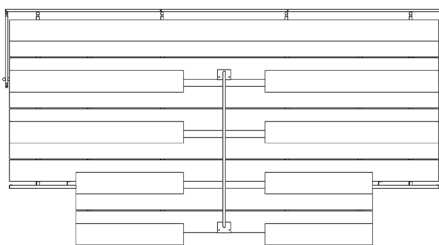

1186-ADA-2 Option Top View

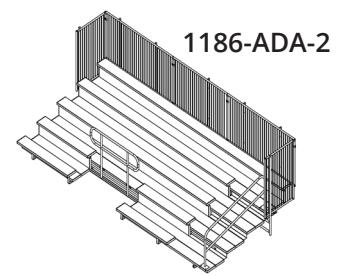
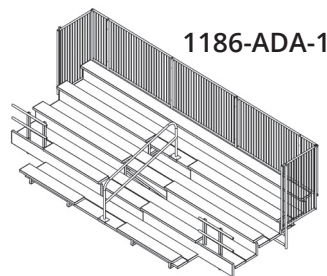
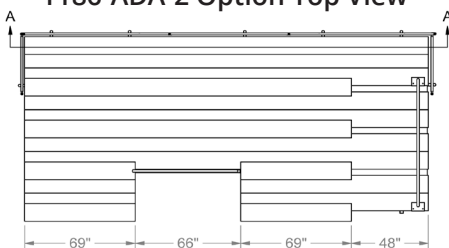

CAUTION
 BLEACHERS CAN TIP OVER
 Anchoring System is recommended

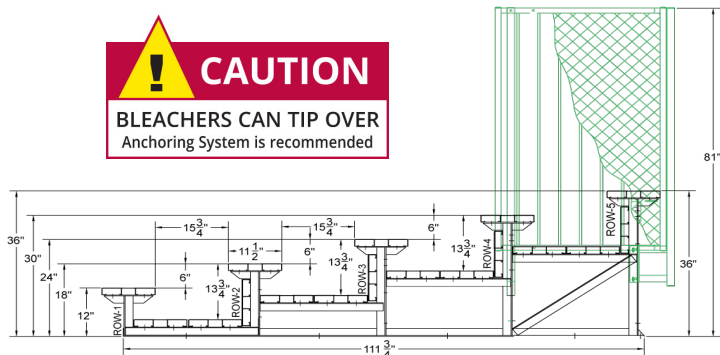

ALUMINUM BENCHES

ALUMINUM SEATING



Model #1103-06P
\$524 Powder Coated Frame

ALUMINUM CURVED BACK BENCH



Model #1103-15
\$781 M2 Mount

Our standard Curved Back design provides seat and back planks made of 2" x 10" heavy-duty anodized, extruded aluminum, mounted on 2-3/8" O.D. Galvanized steel frames. These benches are available in surface mount, in-ground mount or portable mount. Bench frames are available as galvanized or powder coated. Quick Ship items are available in galvanized only. Powder coat colors page 2.

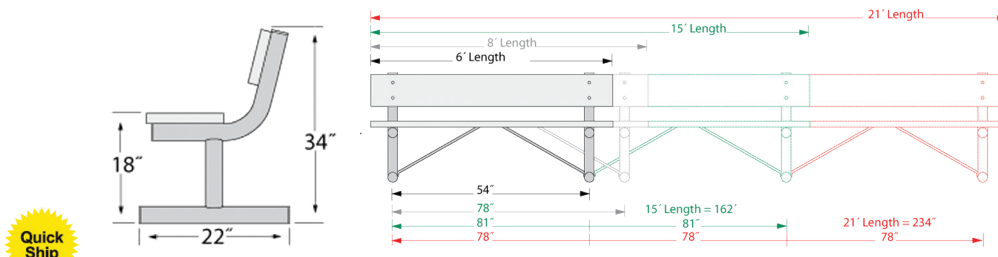

Aluminum Curved Back Bench

Model	Description	Weight	Powder Coat Frame	Galvanized Frame
1103-06	6' Bench, Aluminum Seat & Back, Steel Frame	65 lbs.	\$524	\$422
1103-08	8' Bench, Aluminum Seat & Back, Steel Frame	70 lbs.	\$575	\$473
1103-15	15' Bench, Aluminum Seat & Back, Steel Frame	112 lbs.	\$943	\$781
1103-21	21' Bench, Aluminum Seat & Back, Steel Frame	165 lbs.	\$1,185	\$977
Upcharge to Powder Coat Aluminum Planks			\$7.00 per ft.	

(Add -P to model # for powder coated frame)

SCORERS TABLE



Model #1178-06RCA-P
\$977 Powder Coated Frame

A durable scorers table especially suitable for dugouts or wherever a worktable is needed. Frames are fabricated from aluminum angle, and the planks are available in 2" x 10" nominal Recycled Plastic or extruded Aluminum. Benches are available in 6', 8' lengths. Powder coat colors page 2.

Scorers Table - Aluminum Frame

Model	Description	Weight	Powder Coat Frame	Unfinished Frame
1178-06A	6' Scorer's Table with Aluminum Planks	135 lbs.	\$775	\$710
1178-06RCA	6' Scorer's Table with Recycled Composite Planks	146 lbs.	\$977	\$877
Upcharge to Powder Coat Aluminum Planks			\$7.00 per ft.	

(Add -P to model # for powder coated frame)

DUGOUT PLAYERS BENCH WITH SHELF

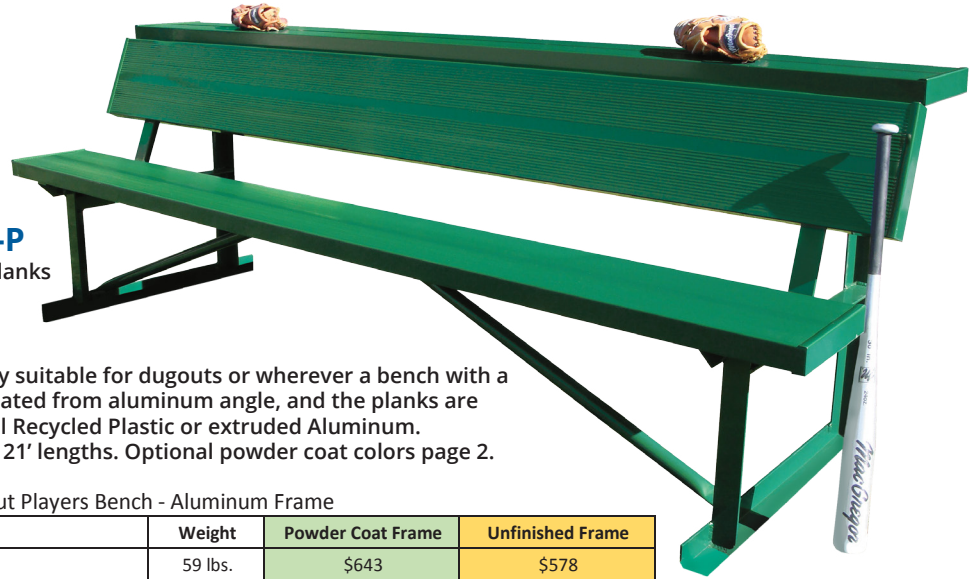

Model #1176-08A-P
\$708 Powder Coat Frame & Planks

A durable aluminum bench especially suitable for dugouts or wherever a bench with a shelf is needed. Frames are fabricated from aluminum angle, and the planks are available in 2" x 10" nominal Recycled Plastic or extruded Aluminum. Benches are available in 6', 8', 15' & 21' lengths. Optional powder coat colors page 2.

Dugout Players Bench - Aluminum Frame

Model	Description	Weight	Powder Coat Frame	Unfinished Frame
1176-06A	6' Bench with Aluminum Planks	59 lbs.	\$643	\$578
1176-08A	8' Bench with Aluminum Planks	67 lbs.	\$708	\$643
1176-15A	15' Bench with Aluminum Planks	115 lbs.	\$1,173	\$1,108
1176-21A	21' Bench with Aluminum Planks	160 lbs.	\$1,469	\$1,404
Upcharge to Powder Coat Aluminum Planks			\$7.00 per ft.	
1176-06R	6' Bench with Recycled Composite Planks	103 lbs.	\$909	\$809
1176-08R	8' Bench with Recycled Composite Planks	128 lbs.	\$1,099	\$949

(Add -P to model # for powder coated frame)

PLAYERS BENCH WITHOUT BACK

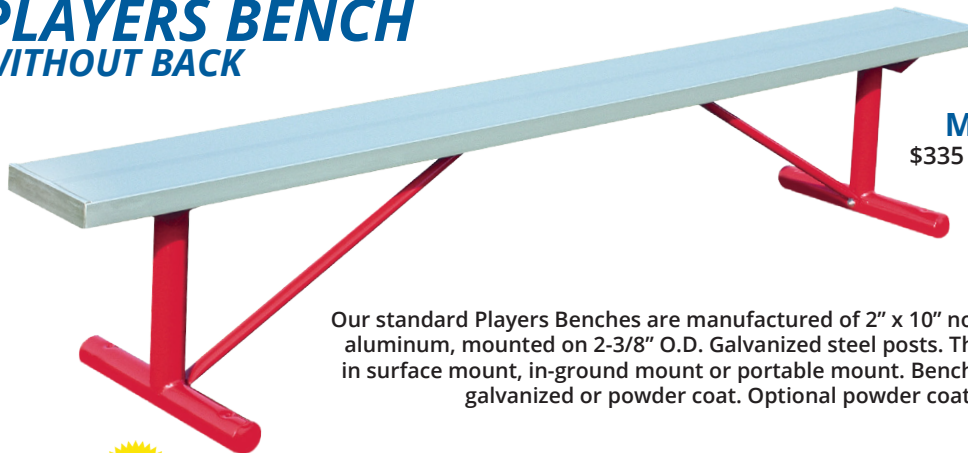

Model #1119-08
\$335 Powder Coated Frame

Our standard Players Benches are manufactured of 2" x 10" nominal heavy-duty extruded aluminum, mounted on 2-3/8" O.D. Galvanized steel posts. These benches are available in surface mount, in-ground mount or portable mount. Bench frames come standard as galvanized or powder coat. Optional powder coat colors page 2.



Players Bench

Model	Description	Weight	Powder Coat Price	Galvanized Price
1119-06	6' Aluminum Players Bench without Back, 10" Plank	56 lbs.	\$313	\$233
1119-06W	6' Aluminum Players Bench without Back, 12" Plank	60 lbs.	\$328	\$245
1119-08	8' Aluminum Players Bench without Back, 10" Plank	53 lbs.	\$335	\$254
1119-15	15' Aluminum Players Bench without Back, 10" Plank	75 lbs.	\$521	\$422
1119-21	21' Aluminum Players Bench without Back, 10" Plank	105 lbs.	\$659	\$550

MOUNTING OPTIONS

When applicable to the products you are ordering, please select your preferred mounting option and include the model option to the end of the model of your product.



M1
Permanent Mount



M2
Portable



M3
Round Surface Mount



M4
Rectangle Surface Mount



DC1
1 Piece
\$28 per post



DC2
2 Piece
\$53 per post

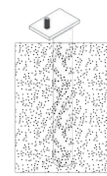

DA
Drop In Anchor
\$16 Each

RECYCLED BENCHES

PARK & SITE



Model #1108-06
\$646 with M1 Mount Option

RECYCLED COMPOSITE CURVED BACK BENCH

Our Curved Back Bench design is available in 2" x 10" recycled composite seats and back with 2-3/8" O.D. frames. Recycled composite provides long life and low maintenance. These benches are available in surface mount, in-ground mount or portable mount. Powder coat colors available on page 2.

Recycled Composite Curved Back Bench

Model	Description	Weight	Powder Coat Price
1108-06P	6' Recycled Composite Bench with Back	125 lbs.	\$646
1108-08P	8' Recycled Composite Bench with Back	150 lbs.	\$728



Model #1107-06
\$370 with M1 Mount Option

RECYCLED COMPOSITE BENCH

The same as our Recycled Plastic curved back bench, our recycled composite players bench without a back features 2" x 10" recycled composite planks for long life and low maintenance. The frames are manufactured of 2-3/8" O.D. Galvanized steel. Powder coat colors available on page 2.

Recycled Composite Bench

Model	Description	Weight	Powder Coat Price
1107-06P	6' Recycled Composite Bench without Back	65 lbs.	\$370
1107-08P	8' Recycled Composite Bench without Back	85 lbs.	\$419



Model #1112-08
\$1,294 with Designer DC2 Plates

4" X 4" RECYCLED COMPOSITE BENCH WITH BACK

These massive benches are manufactured from 4" x 4" recycled composite planks in 6 ft. and 8 ft. lengths. The outside composite come with a radius edge for a more architectural appeal. Recycled composite colors available pg. 2. The frames are made from round 2-7/8" O.D. Galvanized steel. Powder coat colors available page 2.

4" x 4" Recycled Composite Bench

Model	Description	Weight	Powder Coat Price
1112-06	6' (4" x 4") Recycled Composite Bench with Back	215 lbs.	\$879
1112-08	8' (4" x 4") Recycled Composite Bench with Back	254 lbs.	\$1,135



Model #1115-06
\$670 with M3 Mount Option

4" X 4" RECYCLED COMPOSITE BENCH WITHOUT BACK

These 4 plank benches are made from 4" x 4" recycled composite in 6 ft. and 8 ft. lengths. The outside planks come with a radius edge for a more architectural appeal. Recycled composite colors available pg. 2. The frames are made from 2-7/8" O.D. Galvanized steel with 3/8" x 4-1/2" welded flat bar supports. Powder coat colors available page 2.

4" x 4" Recycled Composite Bench without Back

Model	Description	Weight	Powder Coat Price
1115-06	6' (4" x 4") Recycled Composite Bench without Back (4 Planks)	132 lbs.	\$670
1115-08	8' (4" x 4") Recycled Composite Bench without Back (4 Planks)	151 lbs.	\$760



MOUNTING OPTIONS

When applicable to the products you are ordering, please select your preferred mounting option and include the model option to the end of the model of your product.



M1
Permanent Mount



M2
Portable



M3
Round Surface Mount



M4
Rectangle Surface Mount



DC1
1 Piece
\$28 per post



DC2
2 Piece
\$53 per post

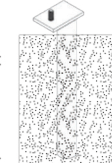

DA
Drop In Anchor
\$16 Each

3" X 4" RECYCLED COMPOSITE BENCH WITH BACK

These Heavy Duty benches are manufactured from 3" x 4" recycled composite planks in 4 ft., 6 ft. and 8 ft. lengths. The edge of seats and backs come with a "Bull Nose" radius edge for a more architectural appeal. The frames are made from round 2-7/8" O.D. Galvanized steel with 3/8" x 4-1/2" welded flat bar supports. Bracing is made from 3/8" x 2" flat bar and 1-1/2" angle. Optional armrest is made from 3/8" x 2" flat bar. Powder coat and composite plank colors available on page 2.



Model #1113-06
\$847 with M4 Mount Option

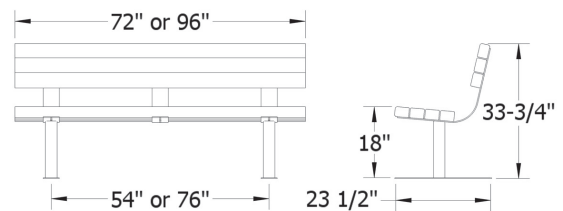

3" x 4" Recycled Composite Bench

Model	Description	Weight	Powder Coat Price
1113-04	4' (3" x 4") Recycled Composite Bench with Back	190 lbs.	\$695
1113-06	6' (3" x 4") Recycled Composite Bench with Back	210 lbs.	\$847
1113-08	8' (3" x 4") Recycled Composite Bench with Back	275 lbs.	\$1,036
1113-AR	Optional Armrest (1 Pair)	10 lbs.	\$69



Model #1123-06
\$632 with Designer DC1 Plate

3" X 4" RECYCLED COMPOSITE BENCH WITHOUT BACK

The backless companion to our #1113 bench. These Heavy Duty benches are manufactured from 3" x 4" recycled composite planks in 4 ft., 6 ft. and 8 ft. lengths. The outside planks come with a "Bull Nose" radius edge. The frames are made from round 2-7/8" O.D. Galvanized steel with 3/8" x 4-1/2" welded flat bar supports. Powder coat and composite plank colors available on page 2.

3" x 4" Recycled Composite Bench without Back

Model	Description	Weight	Powder Coat Price
1123-04	4' (3" x 4") Recycled Composite Bench without Back	120 lbs.	\$464
1123-06	6' (3" x 4") Recycled Composite Bench without Back	160 lbs.	\$580
1123-08	8' (3" x 4") Recycled Composite Bench without Back	205 lbs.	\$698



RAINBOW BENCH WITH BACK

A perfect match for our Rainbow series Bike Racks. This bench is manufactured with 2-3/8" O.D. Galvanized Steel. Various mounting options are available. Planks are available with in two sizes of Recycled Composite. Powder coat and plastic plank colors available on page 2.



Model #1117-08
\$1,153 with M3 Mount Option

Rainbow Bench

Model	Description	Weight	Powder Coat Price
1116-06	6' (2" x 10") Recycled Composite Bench with Back	180 lbs.	\$824
1116-08	8' (2" x 10") Recycled Composite Bench with Back	200 lbs.	\$934
1117-06	6' (3" x 4") Recycled Composite Bench with Back	195 lbs.	\$1,043
1117-08	8' (3" x 4") Recycled Composite Bench with Back	210 lbs.	\$1,153

RECYCLED BENCHES



Model #1102-08
\$971 with M3 Mount Option

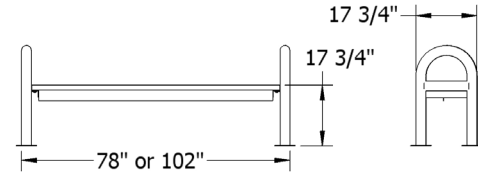

RAINBOW BENCH WITHOUT BACK

A perfect match for our Rainbow series Bike Racks. Our Rainbow Bench is manufactured from 2-7/8" O.D. Galvanized Steel. Various mounting options are available. Planks are 2" x 10" nominal Recycled Composite. Powder coat and plastic plank colors available on page 2.

Rainbow Bench without Back

Model	Description	Weight	Powder Coat Price
1102-06	6' (2" x 10") Recycled Composite Bench without Back	110 lbs.	\$889
1102-08	8' (2" x 10") Recycled Composite Bench without Back	200 lbs.	\$971

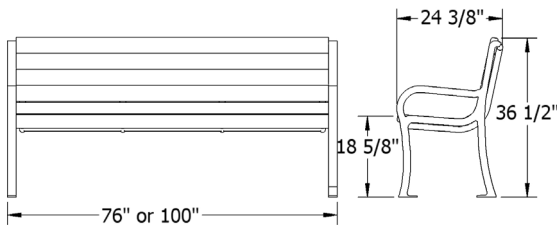

RECYCLED CURVED BACK BENCH

This heavy duty bench with solid Aluminum cast end frames and 2" x 4" recycled plastic planks will be a beautiful addition to any landscape design. The bench is offered in 6' or 8' lengths. Powder coat and composite plank colors available on page 2.

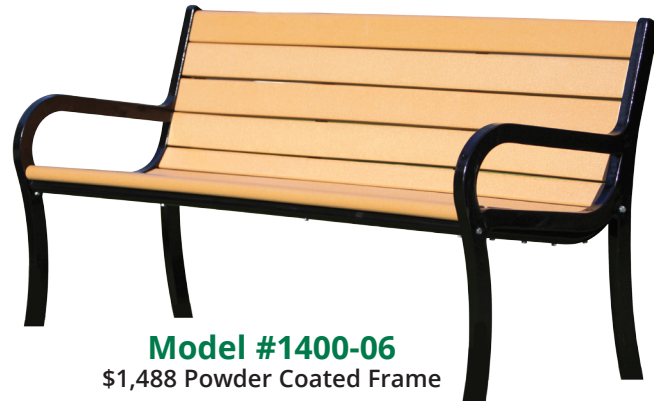

Model #1400-06
\$1,488 Powder Coated Frame

Recycled Curved Back Bench

Model	Description	Weight	Powder Coat Price
1400-06	6' (2" x 4") Recycled Composite Bench with Back	355 lbs.	\$1,488
1400-08	8' (2" x 4") Recycled Composite Bench with Back	385 lbs.	\$1,895



Model #1410-06
\$1,153 Powder Coated Frame

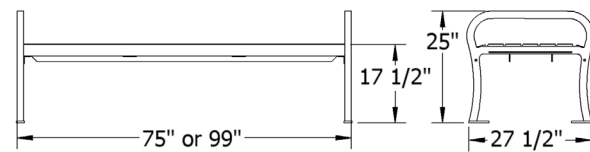

RECYCLED BENCH

This heavy duty bench with solid Aluminum cast end frames and 2" x 4" recycled composite planks will be a beautiful addition to any landscape design. The bench is offered in 6' or 8' lengths. Powder coat and composite plank colors available on page 2.

Recycled Bench

Model	Description	Weight	Powder Coat Price
1410-06	6' (2" x 4") Recycled Composite Bench without Back	210 lbs.	\$1,153
1410-08	8' (2" x 4") Recycled Composite Bench without Back	240 lbs.	\$1,368



RECYCLED BENCHES

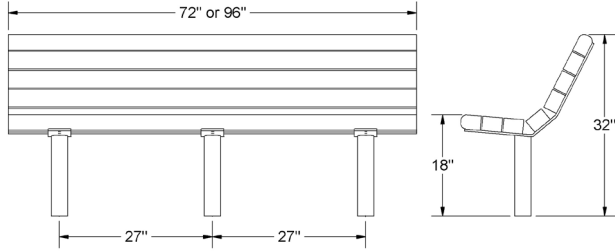

RIVERVIEW BENCH

Manufactured from 2-7/8" O.D. Galvanized steel with our super durable powder coat finish, this bench can be ordered with 2" x 4" or 3" x 4" recycled composite planks. Offered in 6' or 8' lengths. All mounting options available. Powder coat and composite plank colors available on page 2.

Model #1118-06
\$995 with M3 Mount Option

Riverview Bench

Model	Description	Weight	Powder Coat Price
1118-16	6' Recycled Bench with 2" x 4" Planks	211 lbs.	\$768
1118-18	8' Recycled Bench with 2" x 4" Planks	236 lbs.	\$891
1118-06	6' Recycled Bench with 3" x 4" Planks	261 lbs.	\$995
1118-08	8' Recycled Bench with 3" x 4" Planks	303 lbs.	\$1,206



GOLDEN GATE BENCH

Manufactured from 2-7/8" O.D. Galvanized steel with 5-9/16" O.D. end supports. With 2" x 4" recycled composite planks and Heavy Duty Steel under-structure, this bench has extra strength to hold up to the demands of everyday use. Powder coat and composite plank colors available on page 2.

Model #1111-06
\$1,285 with M3 Mount Option



Model #1110-06
\$1050 with DC1 Mount Option

Golden Gate Bench

Model	Description	Weight	Powder Coat Price
1110-06	6' Golden Gate Bench, no back	150 lbs.	\$1,050
1110-08	8' Golden Gate Bench, no back	200 lbs.	\$1,200
1111-06	6' Golden Gate Bench	215 lbs.	\$1,285
1111-08	8' Golden Gate Bench	275 lbs.	\$1,412
1111-ARM	Arm Rests (1 Pair)	5 lbs.	\$66

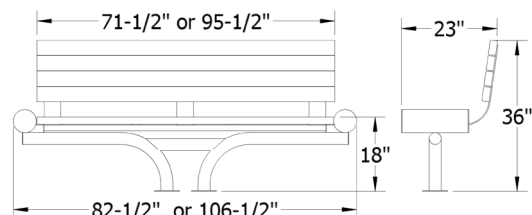
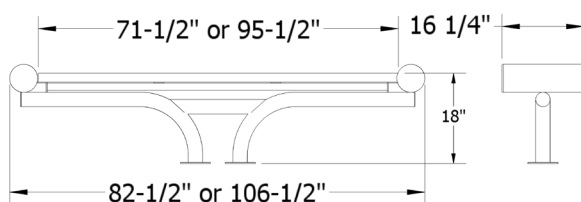

ALUMINUM PICNIC TABLES



Model #1131-06
\$848 Galvanized Frame

EXTRA HEAVY-DUTY ALUMINUM PICNIC TABLE

Our heavy-duty picnic table is designed for "high-traffic" areas like parks or schools. The frame is manufactured of 2-3/8" O.D. Galvanized steel and the planks are 2" x 10" anodized aluminum. The ADA compliant table features an 8' top and 6' seats. Powder coat colors available on page 2.

Extra Heavy-Duty Aluminum Picnic Table

Model	Description	Weight	Powder Coat Frame	Galvanized Frame
1131-06	6' Aluminum 2" x 10" Picnic Table Galvanized Frame	170 lbs.	\$943	\$848
1131-08	8' Aluminum 2" x 10" Picnic Table Galvanized Frame	180 lbs.	\$1,028	\$929
1131-12	12' Aluminum 2" x 10" Picnic Table Galvanized Frame	252 lbs.	\$1,668	\$1,539
1131-ADA	8' Picnic Table with 6' seats, ADA Option	N/A	\$1,028	\$929
10" Powder Coated Plank			\$7.00 per ft.	
CL	Anchor Bracket for 2-3/8" O.D. Picnic Table (Set of 4)	N/A	\$114	

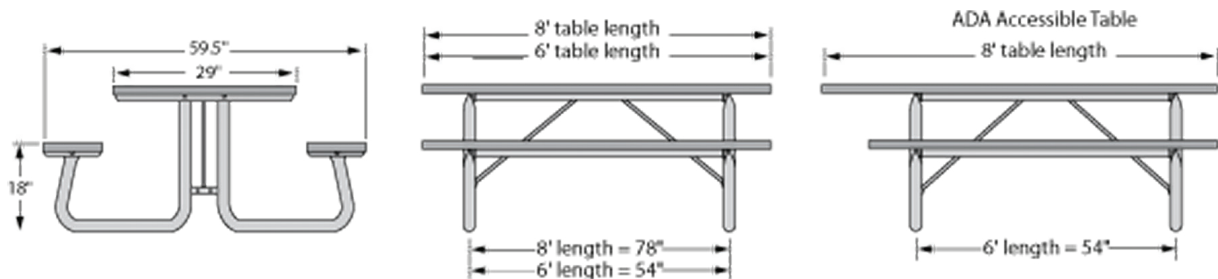

Model #CL
\$114 per set

Anchor bracket allows a picnic table to be secured to a cement pad using concrete anchors. Sold separately.

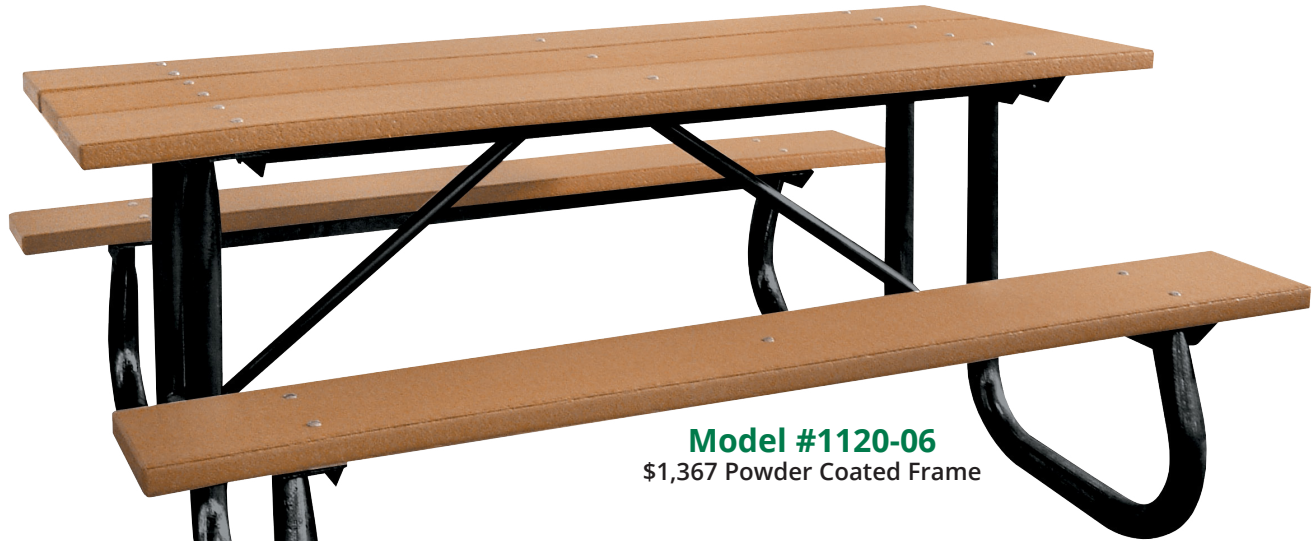

Model #1120-06
\$1,367 Powder Coated Frame

EXTRA HEAVY-DUTY RECYCLED COMPOSITE PICNIC TABLE

Our heavy-duty picnic table with recycled composite provides long life and ease of maintenance. The frame is manufactured of 2-3/8" O.D. Galvanized steel while the planks are manufactured of 2" x 10" recycled plastic. The ADA compliant table features an 8' top and 6' seats. Powder coat and composite plank colors available on page 2.

Extra Heavy-Duty Recycled Composite Picnic Table

Model	Description	Weight	Powder Coat Price
1120-06	6' Recycled Composite, 2-3/8" O.D. Frame	250 lbs.	\$1,367
1120-08	8' Recycled Composite, 2-3/8" O.D. Frame	325 lbs.	\$1,687
1120-ADA	8' Table, 6' Benches, 2-3/8" O.D. Frame	350 lbs.	\$1,493
CL	Anchor Bracket for 2-3/8" O.D. Picnic Table (Set of 4)	8 lbs.	\$114



Most Heavy-Duty Bracing in the Industry!

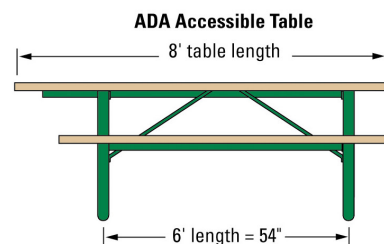
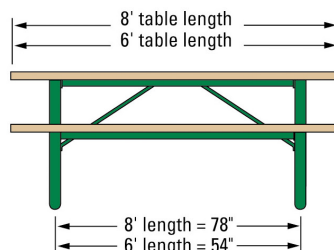
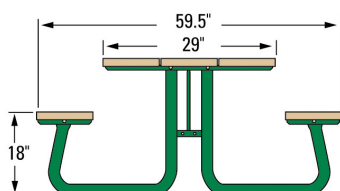

COMPOSITE PICNIC TABLES



Model #1121-12
\$2,475 Powder Coated Frame

EXTRA HEAVY-DUTY RECYCLED COMPOSITE ADA PICNIC TABLE

Our heavy-duty picnic table with recycled composite provides long life and ease of maintenance. The frame is manufactured of 2-3/8" O.D. Galvanized steel while the planks are manufactured of 2" x 10" recycled plastic. This ADA compliant table features a 12' top with (1) 12' long seat, (2) 4.5' seats and a 36" gap, for ease of wheelchair entry. Powder coat and composite plank colors available on page 2.

Extra Heavy-Duty Recycled Composite ADA Picnic Table

Model	Description	Weight	Powder Coat Price
1121-12ADA	12' Recycled Composite, 2-3/8" O.D. Frame, 36" ADA Opening	N/A	\$2,475
CL	Anchor Bracket for 2-3/8" O.D. Picnic Table (Set of 4)	8 lbs	\$114

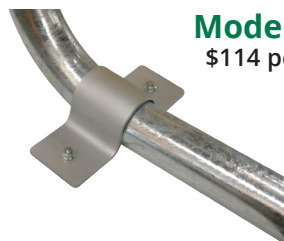
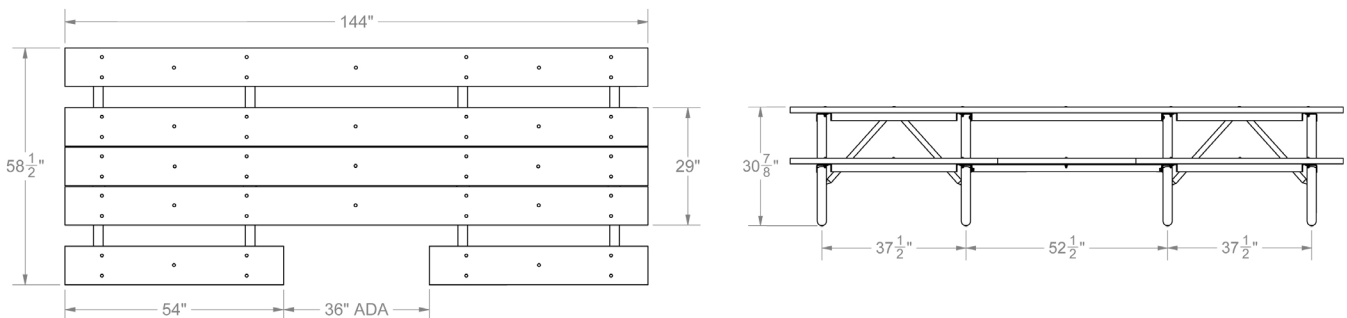

Model #CL
\$114 per set

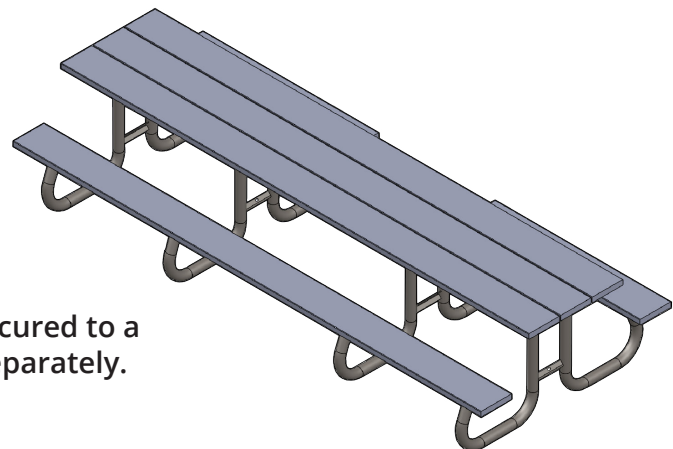

Anchor bracket allows a picnic table to be secured to a cement pad using concrete anchors. Sold separately.

**Our Strongest Table Available!
Built for Institutional Use!**



SOLID STEEL TOP PICNIC TABLE

Model #1145-06
\$891 Galvanized Frame

Our extra heavy-duty picnic table with solid or perforated steel top and seats provides a smooth, one piece surface. Ideal for institutional applications, the frame is manufactured of 2-3/8" O.D. Galvanized steel while the top and seats are formed from 12 gauge steel and reinforced with 1-1/2" square steel. Powder coat colors available on page 2.



PERFORATED STEEL TOP PICNIC TABLE

Model #4220-06P
\$1,553 Powder Coated Frame

Standard price includes powder coated table and seat tops. Galvanized table tops available at no additional charge with **Extra Heavy-Duty braces**

Extra Heavy-Duty Steel Top & Seat Picnic Table

Model	Description	Weight	Powder Coated Top & Frame	Powder Coated Top Galvanized Frame
1145-06	6' Solid Steel Top/Seat Picnic Table	200 lbs.	\$1,016	\$891
1145-08	8' Solid Steel Top/Seat Picnic Table	225 lbs.	\$1,178	\$996
1145-ADA	8' Solid Steel Top 6' Seats Picnic Table	225 lbs.	\$1,178	\$996
4220-06	6' Perforated Steel Top/Seat Picnic Table	200 lbs.	\$1,553	\$1,404
4220-08	8' Perforated Steel Top/Seat Picnic Table	225 lbs.	\$1,619	\$1,467
4220-ADA	8' Perforated Steel Top 6' Seats Picnic Table	225 lbs.	\$1,619	\$1,467
CL	Anchor Bracket for Picnic Table (Set of 4)	8 lbs.	\$114	

PEDESTAL PICNIC TABLES

4' SQUARE PEDESTAL TABLE



Model #1144-04
\$2,638 Powder Coated Frame

This new 4' Square Pedestal Table has 2" x 10" Recycled Plastic Planks for the table top and the seats, and has a 4" x 4" steel tube structure for in-ground mounting. Powder coat and plastic plank colors available on page 2.

4' Square Pedestal Table, with 2" x 10" Recycled Composite Planks

Model	Description	Weight	Powder Coat Price
1144-04	4' Square Pedestal Table, 4 bench seats	426 lbs.	\$2,638
1144-04ADA	4' Square Pedestal Table, 3 bench seats	375 lbs.	\$2,509
	Surface Mount Option, Add	N/A	\$89

SINGLE PEDESTAL PICNIC TABLE



Model #1143-06
\$1,499 Powder Coated Frame



Model #1142-06
\$1,259 Powder Coated Frame

This ADA compliant pedestal-style picnic table features a 4" square galvanized post and a seat support manufactured of 2-3/8" O.D. welded steel, powder coated. Choose from 2" x 10" anodized aluminum or recycled composite planking for tabletop and seats. Powder coat and composite plank colors available on page 2.

Single Pedestal Picnic Table, with 2" x 10" Planks

Model	Description	Weight	Powder Coat Price
1142-06	Single Pedestal 6' Picnic Table with Aluminum Planks	180 lbs.	\$1,259
1143-06	Single Pedestal 6' Picnic Table of Recycled Composite	265 lbs.	\$1,499
	Surface Mount Option, Add	N/A	\$89

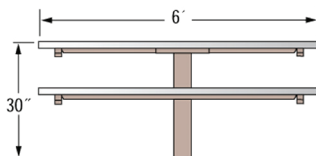
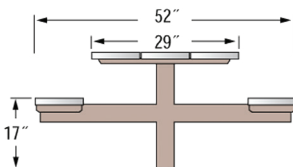

GAME BOARD ADD-ON OPTION



Model #GBI-Chess
\$200

18" x 18" including a 1" border to fasten to table of your choice, 3 layer powder coat includes a clear coat finish.



3" x 4" RECYCLED PLASTIC PICNIC TABLE

This heavy-duty picnic table with recycled plastic provides long life and ease of maintenance. The frame is manufactured of 2-3/8" O.D. Galvanized steel while the planks are manufactured of massive 3" x 4" recycled plastic. The outside planks come with a radius edge for a more architectural appeal. The ADA compliant table comes with an 8' top and 6' seats. Powder coat and plastic plank colors available on page 2.

Model #1128-06P
\$1,789 Powder Coated Frame

3" x 4" Recycled Composite Picnic Table

Model	Description	Weight	Powder Coat Frame
1128-06P	6' Picnic Table, 2-3/8" O.D. J Frame	450 lbs.	\$1,789
1128-08P	8' Picnic Table, 2-3/8" O.D. J Frame	567 lbs.	\$2,098
1128-ADA	8' Picnic Table with 6' Seats, 2-3/8" O.D. J Frame	505 lbs.	\$2,123
CL	Anchor Bracket for Picnic Table (Set of 4)	195 lbs.	\$114



GAME BOARD ADD-ON OPTION



Model #GBI-Chess
\$200

18" x 18" including a 1" border to fasten to table of your choice, 3 layer powder coat includes a clear coat finish.

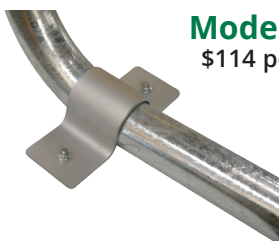

Model #CL
\$114 per set

Anchor bracket allows a picnic table to be secured to a cement pad using concrete anchors. Sold separately.

RECYCLED PICNIC TABLES



Model #1126-06
\$2,278 Powder Coated Frame

4" x 4" MULTI-PEDESTAL PICNIC TABLE

These massive tables and benches are manufactured from 4" x 4" recycled plastic planks in 6 ft. and 8 ft. lengths. The outside planks come with a radius edge for a more architectural appeal. Table comes standard with 2-7/8" O.D. legs Powder coat and plastic plank colors available on page 2.

4" x 4" Recycled Composite Multi-Pedestal Picnic Table

Model	Description	Weight	Powder Coat Price
1126-06	6' Picnic Table, 2-7/8" O.D. Supports	510 lbs.	\$2,278
1126-08	8' Picnic Table, 2-7/8" O.D. Supports	643 lbs.	\$2,507
1126-ADA	8' Picnic Table with 6' Seats, 2-7/8" O.D. Supports	575 lbs.	\$2,507

Choose In-Ground Mount or Surface Mount when ordering



GAME BOARD ADD-ON OPTION



Model #GBI-Chess
\$200

18" x 18" including a 1" border to fasten to table of your choice, 3 layer powder coat includes a clear coat finish.



LITTER RECEPTACLES

ROUND STEEL TOP LITTER RECEPTACLE

Heavy-Duty Receptacle made with 2-3/8" O.D. steel tubing frame and 2" x 4" Recycled Composite Planking. All receptacles shipped with 32 gallon removable plastic container. Surface mount is standard, optional In-Ground Mount. Powder coat and composite plank colors available on page 2.

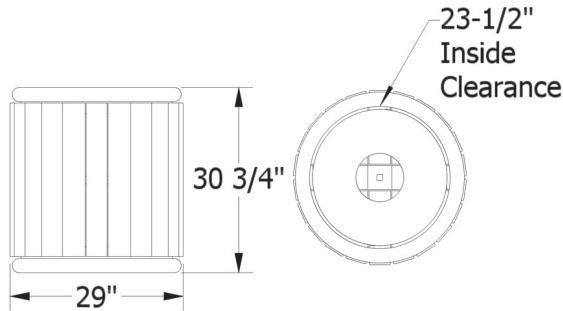

Model #1450
\$1,198 Powder Coated Price

Round Steel Top Litter Receptacle

Model	Description	Weight	Powder Coat Price
1450	Litter Receptacle with Recycled Composite Planks	211 lbs.	\$1,198
1450-SH	Litter Receptacle with Recycled Composite Planks & Side Opening	211 lbs.	\$1,398
	In-Ground Mount Option	N/A	\$50

LITTER RECEPTACLE

Made of 2"x 4" recycled composite planks with a steel frame construction. All receptacles shipped with 32 gallon removable plastic container. Surface mount standard with in-ground option. PW offers lids in two styles including a flat steel or domed. Composite plank colors available on page 2.

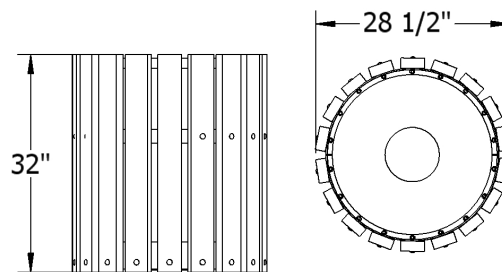
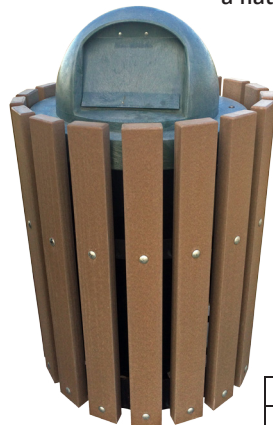

Round Litter Receptacle, Recycled Composite Planks

Model	Description	Weight	Powder Coat Price
1150	Litter Receptacle, Flat Lid, Surface Mount	107 lbs.	\$713
1150-M1	Litter Receptacle, Flat Lid, In-Ground Mount (M1)	115 lbs.	\$813
1150-NL	Litter Receptacle, No Lid, Surface Mount	99 lbs.	\$663
1150-PL	Litter Receptacle, Plastic Dome Lid, Surface Mount	107 lbs.	\$813
1150-PL-M1	Litter Receptacle, Plastic Dome Lid, In-Ground Mount	115 lbs.	\$913
SL	Flat Steel Lid, Sold Separately	7.55 lbs	\$186
PS	Plastic Dome Lid - Sold Separately	7.2 lbs	\$257

Model #1150
\$713 with Composite Planks

Plastic Dome Lid Color Options

Contrasting Plank and Lid Colors recommended when ordering



Black, Brown, Grey, Green, Ivory, Red

LITTER RECEPTACLES

SQUARE LITTER RECEPTACLE

Heavy-Duty Trash Container with 2" x 2" steel tubing frame and 2" x 4" Recycled Composite Planking. All receptacles shipped with 32 gallon removable plastic container. The unit comes with a side-opening door with hidden latch. It comes surface mount only. Powder coat and composite plank colors available on page 2.

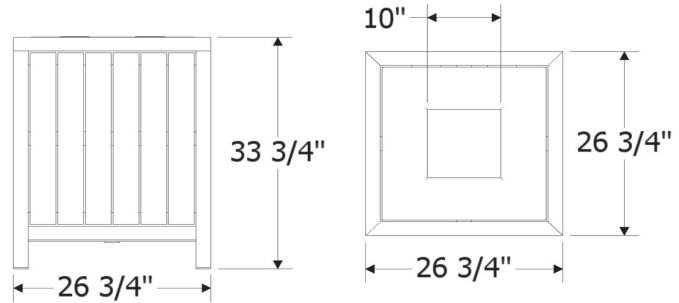

Square Litter Receptacle, Side Entry

Model #1307-02RCP
\$1,486 Powder Coated Price

Model	Description	Weight	Powder Coat Price
1307-02RCP	Heavy-Duty Litter Receptacle with Recycled Composite Planks	265 lbs.	\$1,486
1307-02BAR	Heavy-Duty Litter Receptacle with 1-1/2" Steel Bar Sides	249 lbs.	\$1,048
1307-02ROD	Heavy-Duty Litter Receptacle with 1-1/2" Steel Rod Sides	251 lbs.	\$1,048

Model #1307-02ROD
\$1,048 Powder Coated Price



Model #1307-02BAR
\$1,048 Powder Coated Price

LITTER CAN HOLDERS

Our litter can holders are manufactured of strong, galvanized steel and can lock either one or two 20 to 32 gallon capacity litter cans in place. These litter can holders have been designed as a means of preventing vandalism while permitting easy removal for emptying. Cans may be used with or without lids. Padlocks and cans are not supplied. Powder coat colors available on page 2.



Model #1151-01
\$316 Powder Coated Price
(Can NOT included)

Litter Can Holders

Model	Description	Weight	Powder Coat Price	Galvanized Price
1151-01	Single Litter Can Holder	25 lbs.	\$316	\$208
1151-02	Double Litter Can Holder	35 lbs.	\$354	\$246

RECYCLING RECEPTACLE

Made of 2" square steel frame construction with your choice of 2"x4" recycled composite planks or 1-1/2" x 3/16" thick steel slats. All receptacles shipped with 3 ea 11"x 21-1/2" x 27" removable galvanized liners. Surface mount standard. Side opening. Composite plank colors page 2.

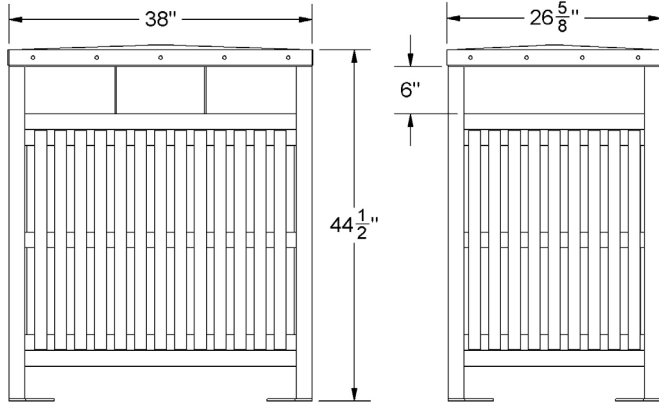

Model #1308-BAR
\$2,038 Powder Coated Price

Recycling Receptacle

Model	Description	Weight	Powder Coat Price
1308-BAR	Divided Recycling Receptacle, 1-1/2" Steel Slat 25 Gallons	N/A	\$2,038
1308-RCP	Divided Recycling Receptacle, 2" x 4" Recycled Composite Planks 25 Gallons	N/A	\$2,088

Promote environmental and community health & wellness with the PW Athletic Recycling Receptacle. This receptacle is the perfect waste solution for any situation. Featuring 3 separate high quality galvanized steel liners, this receptacle not only looks amazing...but is built to stand the test of time.

CORRUGATED LITTER RECEPTACLE



Model #1390
\$45 (5/pack with Tape)



Model #1308-RCP
\$2,088 Powder Coated Price

Corrugated Litter Receptacles (5/pack)

Model	Description	Weight	Price
1390	17" x 17" x 36"Ht with Tape Pad for Assembly	N/A	\$45

GRILLS & FIRE RINGS



Quick Ship

Model #1140-10
\$633 with In-Ground Mount
Side Shelves Available at
additional cost.



Quick Ship

Model #1140-20
\$961 with Surface Mount



Quick Ship

Model #1140-00
\$350 with In-Ground Mount
Side Shelves Available at
additional cost.



Grills

Model	Description	Weight	Price
1140-00	Single Grill, 15" x 20", In-Ground Mount	70 lbs.	\$350
1140-00SH	7" x 20" Shelf for Single Grill	8 lbs.	\$49
1140-05	Single Grill, Galvanized, In-Ground Mount	70 lbs.	\$474
1140-05SH	7" x 20" Shelf for Single Grill, Galvanized	8 lbs.	\$46
1140-10	Double Grill, 32" x 20", In-Ground Mount	140 lbs.	\$633
1140-10SH	7.5" x 9.5" Side Shelf for Double Grill	4 lbs.	\$51
1140-20	28" x 36" Large Group Grill with Shelf, Surface Mount	215 lbs.	\$961
SM	Surface Mount Option for Single or Double Grill	6 lbs.	\$76

FIRE RINGS

Fire Rings are available in 3 sizes, all 32" in diameter. Fabricated from 1/4" plate steel with a formed 1" flanged tip around the top and 1" diameter draft holes spaced around the bottom perimeter. Entire unit is finished in high temperature, heat resistant, nontoxic black enamel paint.



Quick Ship

Model #1141-06
\$317 with Adjustable Grate
Side Shelves Available at
additional cost.

Model	Description	Weight	Price
1141-06	6" Tall Fire Ring with Adjustable Grate	80 lbs.	\$317
1141-07	7" Tall Fire Ring with Adjustable Grate	70 lbs.	\$329
1141-09	9" Tall Fire Ring with Adjustable Grate	90 lbs.	\$591
1141-06SH	7" x 9.5" Curved Grill Shelf	4 lbs.	\$66



Quick Ship

Model #1141-09
\$591 with Adjustable Grate
Side Shelves Available at
additional cost.

NEWPORT BIKE RACK

The Newport Bike Rack is constructed from 2-3/8" O.D. steel horizontal rails and 1-5/8" O.D. vertical rails. Rack ends consist of 3/8" x 4-1/2" flat bar mounting plates and 2-3/8" O.D. steel, welded one piece end design. Holds 8 bikes. Powder coat colors available on page 2.

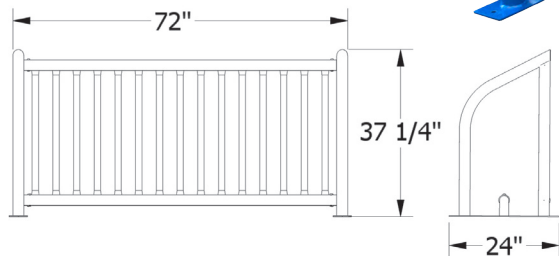

Model #1606-06
\$875 Powder Coated Price

Newport Bike Rack

Model	Description	Weight	Price
1606-06	72"L x 24"W x 35"H (Holds 8 Bikes)	138 lbs.	\$875

BOW-RACK BIKE RACK

The Bow-Rack is a welded one-piece design that holds 6 bikes. This unique design is constructed from 4" square galvanized steel support posts, 2-7/8" O.D. Galvanized Arch Top Rail and 1-5/8" O.D. Galvanized vertical rails. Powder coat colors available on page 2.

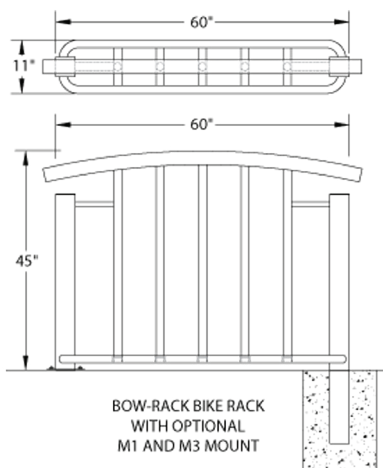

Model #1614-06
\$849 Powder Coated Price

Bow-Rack Bike Rack

Model	Description	Weight	Price
1614-06	60"L x 11"W x 45"H (Holds 6 Bikes)	98 lbs.	\$849

BIKE RACKS



Model #1610-08
\$779 with M3 Surface Mount

OXFORD BIKE RACK

The Oxford bike rack gets its support from either 4-1/2" O.D. or 3-1/2" O.D. steel with curved 90 degree bends. Manufactured of galvanized steel and welded at the factory for easy installation. Standard mounting options include: M1 or M3. Powder coat colors available on page 2.

Oxford Bike Rack

Model	Description	Weight	Powder Coat Price
1610-16	3-1/2" Frame, 72"L x 36"H, 6 Spaces	120 lbs.	\$667
1610-18	3-1/2" Frame, 94"L x 36"H, 8 Spaces	145 lbs.	\$700
1610-20	3-1/2" Frame, 120"L x 36"H, 10 Spaces	170 lbs.	\$740
1610-06	4-1/2" Frame, 72"L x 36"H, 6 Spaces	160 lbs.	\$726
1610-08	4-1/2" Frame, 94"L x 36"H, 8 Spaces	190 lbs.	\$779
1610-10	4-1/2" Frame, 120"L x 36"H, 10 Spaces	220 lbs.	\$840

CAMBRIDGE BIKE RACK

Constructed of 3-1/2", 4-1/2" or 5-9/16" O.D. Galvanized steel support posts. The interior rail is made of 1-5/8" O.D. Galvanized steel. The entire rack is welded into one piece. Powder coat colors available on page 2.

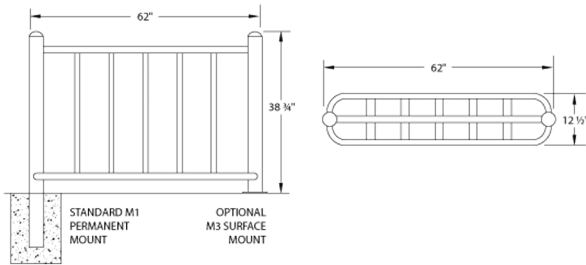

Model #1609-05
\$783 with Designer DC2 Plates

Cambridge Bike Rack

Model	Description	Weight	Powder Coat Price	Galvanized Price
1609-03	3-1/2" O.D. (Holds 6 Bikes) 58" Length	151 lbs.	\$612	\$586
1609-04	4-1/2" O.D. (Holds 6 Bikes) 60" Length	171 lbs.	\$667	\$641
1609-05	5-9/16" O.D. (Holds 6 Bikes) 62" Length	181 lbs.	\$677	\$651



Model #1700-00
\$277 with M3 Surface Mount

ROUND-UP BIKE RACK

The Round-Up Bike Rack is beautifully formed into a circle from Heavy Duty 2-3/8" O.D. Galvanized steel. These racks are sold individually and can be configured in many patterns. Powder coat colors available on page 2.

Round-Up Bike Rack

Model	Description	Weight	Powder Coat Price	Galvanized Price
1700-00	36"H x 42"W (Holds 2 Bikes)	35 lbs.	\$277	\$218



Model #1608-01
\$250 Powder Coated Price

Model #1608-DSP
\$233 with M3 Surface Mount



RAINBOW BIKE RACK

Our Rainbow Bike Racks are beautifully formed to an inverted "U". These racks are sold individually and can be configured in many patterns. Manufactured from either 2-3/8" O.D. Galvanized steel or stainless steel with M1 Permanent Mount. Other mount options available are M3 or M4 Surface Mount, see below. Optional powder coating is available in any of our 16 powder coat colors for an additional charge. Powder Coat colors on page 2. **See page 82 for customization options.**

Rainbow Bike Rack

Model	Description	Weight	Powder Coat Price	Galvanized Price
1608-01P	36" Tall x 23" Wide Rainbow Bike Rack	28 lbs.	\$250	\$223
1608-DSP	Designer Series Rainbow Bike Rack	32 lbs.	\$233	NA
1608-ENG	Custom "Logo" Rainbow Bike Rack	32 lbs.	\$312	NA

ROLLER COASTER BIKE RACK

One of our most popular bike racks for years on end, the roller coaster version features a multi-loop style. Manufactured from either 2-3/8" O.D. Galvanized steel or stainless steel, this unit stands 36" in height. In-Ground mount as standard. Powder coat colors available on page 2.

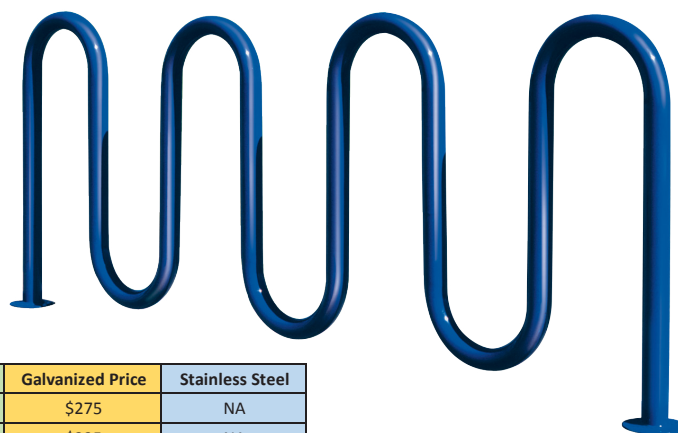

Roller Coaster Bike Rack

Model	Description	Weight	Powder Coat Price	Galvanized Price	Stainless Steel
1601-05	Economy 1-5/8", 5 Spaces, 38" Long	57 lbs.	\$310	\$275	NA
1601-07	Economy 1-5/8", 7 Spaces, 64" Long	86 lbs.	\$365	\$325	NA
1601-09	Economy 1-5/8", 9 Spaces, 87" Long	119 lbs.	\$429	\$359	NA
1602-05	Deluxe 2-3/8", 5 Spaces, 38" Long	60 lbs.	\$412	\$385	Call for pricing
1602-07	Deluxe 2-3/8", 7 Spaces, 64" Long	90 lbs.	\$464	\$424	
1602-09	Deluxe 2-3/8", 9 Spaces, 87" Long	125 lbs.	\$524	\$449	
1602-11	Deluxe 2-3/8", 11 Spaces, 113" Long	155 lbs.	\$635	\$550	
1602-13	Deluxe 2-3/8", 13 Spaces, 139" Long	175 lbs.	\$687	\$592	

Model #1602-09
\$524 with M3 Surface Mount

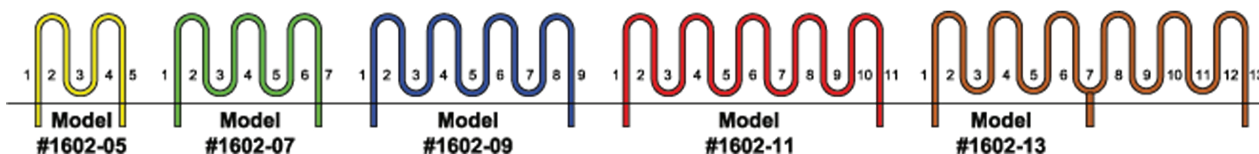

MOUNTING OPTIONS

When applicable to the products you are ordering, please select your preferred mounting option and include the model option to the end of the model of your product.

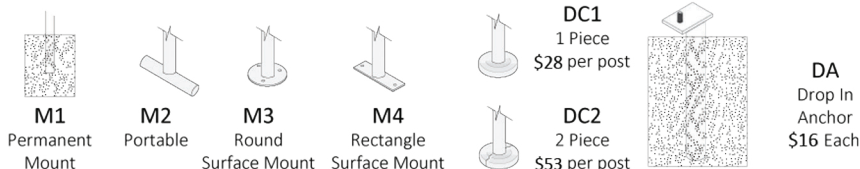

BIKE RACKS

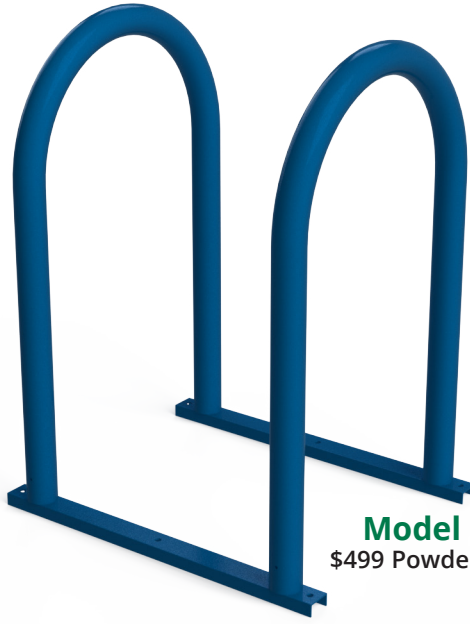

DOUBLE RAINBOW BIKE RACK

The double loop rainbow rack comes with inverted U's manufactured of 2-3/8" O.D. Galvanized steel, attached to two steel rails. The rack is made to accommodate 4 or 8 bikes. Powder coat colors available on page 2.

Double Rainbow Bike Rack

Model	Description	Weight	Powder Coat Price	Galvanized Price
1608-02	2 Loop, 36"H x 23"W x 28"L, (Holds 4 Bikes)	65 lbs.	\$499	\$399
1608-04	4 Loop, 36"H x 23"W x 73"L, (Holds 8 Bikes)	130 lbs.	\$693	\$593

Model #1608-02
\$499 Powder Coated Finish

MINI-RAINBOW BIKE RACK

The Mini-Rainbow Bike Rack is an inverted "U". Manufactured from 1-5/8" O.D. Galvanized Steel. In-Ground mount as standard. Powder coat colors available on page 2.

Mini-Rainbow Bike Rack

Model	Description	Weight	Powder Coat Price	Galvanized Price
1607-01	36"H x 16-1/4"W	9 lbs.	\$186	\$135

Model #1607-01
\$186 with M3 Surface Mount



RINGLET BIKE RACK

This heavy-duty one piece welded bike rack is constructed from 2" x 2" steel angle and 1" steel tube. Powder coat colors available on page 2.

Model #1625-06
\$625 Powder Coated Finish

Ringlet Bike Rack

Model	Description	Weight	Powder Coat Price
1625-04	39"L x 22-1/2"W x 22-1/2"H (Holds 4 Bikes)	69 lbs.	\$516
1625-06	58"L x 22-1/2"W x 22-1/2"H (Holds 6 Bikes)	102 lbs.	\$625
1625-08	77"L x 22-1/2"W x 22-1/2"H (Holds 8 Bikes)	135 lbs.	\$740

ROUND-UP BOLLARD BIKE RACK

Post and rails are fabricated with galvanized steel. All Rails are 2-3/8" O.D. and Post sizes according to model selected. Post caps are cast aluminum and secured with rivets at the factory. Powder coat colors available on page 2.



Round-Up Bollard Bike Rack

Model	Description	Weight	Powder Coat Price
1702-03	Round-Up Bollard Bike Rack 3-1/2" Post with 2 Rails	75 lbs.	\$525
1702-04	Round-Up Bollard Bike Rack 4-1/2" Post with 2 Rails	95 lbs.	\$613
1702-05	5-9/16" Round-Up Bollard Bike Rack with 2 Rails	115 lbs.	\$656

Model #1702-05
\$656 Powder Coated Finish



Model #1650-00
\$296 Powder Coated Finish

Model #1652-04
\$287 Powder Coated Finish

MODERN DESIGN BIKE RACK

A clean modern design for areas with limited space, or multi-use where space is available. Made from 3/8" solid steel flat bar. Powder coat colors available on page 2.

Modern Design Bike Racks

Model	Description	Weight	Powder Coat Price
1650-00	Marquise 36"H x 18"W of 3" Flat Bar (Holds 2 Bikes)	95 lbs.	\$296
1652-04	Rectangular 36"H x 6"W of 4" Flat Bar (Holds 2 Bikes)	95 lbs.	\$287

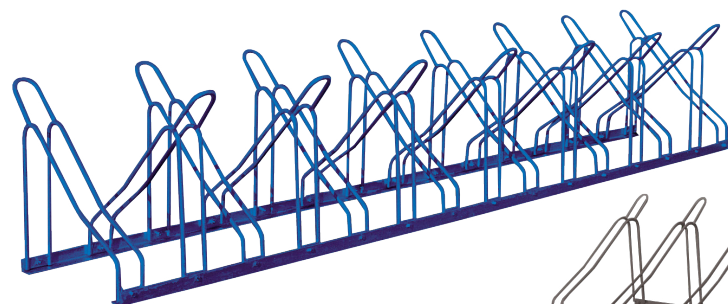

Model #1603-15
\$970 Powder Coated Finish

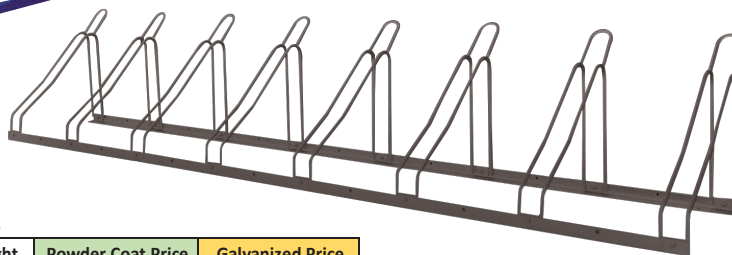

LOOP BIKE RACK

Racks are formed and welded of 1/2" round, galvanized steel rod, designed to accommodate any size bike in an upright position. Available in both double and single side-load styles, the single side load bike rack has loops 16" apart, 21" in height x 18" deep. Powder coat colors available on page 2.

Loop Bike Racks

Model	Description	Weight	Powder Coat Price	Galvanized Price
1603-04	4 Bike Spaces, Single Sided, 4' 3-1/2" Long	40 lbs.	\$508	\$403
1603-08	8 Bike Spaces, Single Sided, 9' 7-1/2" Long	80 lbs.	\$768	\$643
1603-07	7 Bike Spaces, Double Sided, 4' 3-1/2" Long	70 lbs.	\$729	\$614
1603-15	15 Bike Spaces, Double Sided, 9' 7-1/2" Long	122 lbs.	\$970	\$835

Model #1603-08
\$643 Galvanized Finish

BIKE RACKS



ARCH BIKE RACK

The Arch Bike Rack is all galvanized steel, solid weld construction and is manufactured of 1-7/8" O.D. rails and 1-5/16" arches. The rack is 13" in height x 24" deep. Anchoring holes are pre-drilled. Powder Coat colors on page 2.

Model #1604-08
\$426 Powder Coated Finish

Arch Bike Racks

Model	Description	Weight	Powder Coat Price	Galvanized Price
1604-04	4 Bike Spaces, Double Sided, 32" x 24"	39 lbs.	\$278	\$188
1604-08	8 Bike Spaces, Double Sided, 5'3" x 24"	87 lbs.	\$426	\$331
1604-16	16 Bike Spaces, Double Sided, 10'9" x 24"	174 lbs.	\$800	\$665

HEAVY-DUTY STANDARD BIKE RACK

This style of bike rack, manufactured of galvanized steel, is our heaviest and most rugged version available. By design, the bike rack is 30" high x 42" deep and may be entered from both sides. Anchoring holes are pre-drilled. Ships unassembled. Powder Coat colors on page 2.



Heavy-Duty Standard Bike Rack

Model	Description	Weight	Powder Coat Price	Galvanized Price
1607-06	6 Bike Spaces, 2'4" Long	50 lbs.	\$679	\$550
1607-08	8 Bike Spaces, 5'3" Long	80 lbs.	\$775	\$615
1607-16	16 Bike Spaces, 10'4" Long	159 lbs.	\$925	\$743

Model #1607-08

\$775 Powder Coated Finish

SINGLE & DOUBLE SIDED BIKE RACKS

One of our most popular bike racks continues to be the Single & Double Sided Bike Rack. Featuring 1-5/8" O.D. frame and 1-1/16" O.D. rack, this solid steel rack will last for years. The Double Sided can be entered from either side while the Single Sided accommodates a walled area. Anchoring holes are pre-drilled. Powder Coat colors on page 2. Ships unassembled.

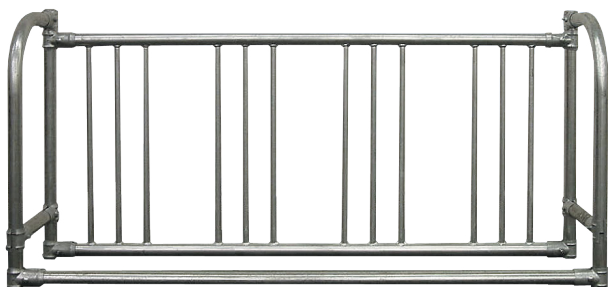

Model #1616-08
\$445 Galvanized Finish

Single Sided Bike Rack

Model	Description	Weight	Powder Coat Price	Galvanized Price
1616-06	6 Bike Spaces, Portable, Surface Mount (51"x16"x30")	90 lbs.	\$582	\$421
1616-08	8 Bike Spaces, Portable, Surface Mount (67"x16"x30")	97 lbs.	\$614	\$445
1616-16	16 Bike Spaces, Portable, Surface Mount (130"x16"x30")	148 lbs.	\$731	\$573
1617-06	6 Bike Space Add On (Attaches to #1616-06) (48-1/2"x16"x30")	80 lbs.	\$555	\$393
1617-08	8 Bike Space Add On (Attaches to #1616-08) (64-1/2"x16"x30")	87 lbs.	\$590	\$421
1617-16	16 Bike Space Add On (Attaches to #1616-16) (127-1/2"x16"x30")	138 lbs.	\$705	\$534

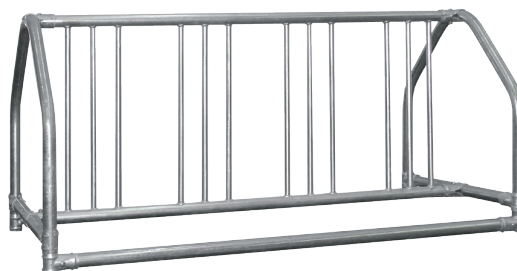

Model #1620-08

\$473 Galvanized Finish

Double Sided Bike Rack

Model	Description	Weight	Powder Coat Price	Galvanized Price
1620-06	6 Bike Spaces, Portable, Surface Mount (51"x32"x30")	109 lbs.	\$614	\$452
1620-08	8 Bike Spaces, Portable, Surface Mount (67"x32"x30")	118 lbs.	\$623	\$473
1620-16	16 Bike Spaces, Portable, Surface Mount (130"x32"x30")	184 lbs.	\$757	\$613
1621-06	6 Bike Space Add On (Attaches to #1620-06) (48-1/2"x32"x30")	99 lbs.	\$590	\$422
1621-08	8 Bike Space Add On (Attaches to #1620-08) (64-1/2"x32"x30")	108 lbs.	\$620	\$453
1621-16	16 Bike Space Add On (Attaches to #1620-16) (127-1/2"x32"x30")	174 lbs.	\$736	\$568



TRADITIONAL BOLLARD POST BIKE RACK

Our Bollard Post Bike Rack provides users with 2 size options, either a 4-1/2" O.D. steel post, or a beefy 5-9/16" O.D. steel post. The rack stands 36" above grade and features a 1-5/16" welded loop rail. The post is a galvanized steel construction and includes a factory installed aluminum cap. Powder coat colors on page 2.

Traditional Bollard Post Bike Rack

Model	Description	Weight	Powder Coat Price
1600-42	4-1/2" O.D. - 2 Rails	61 lbs.	\$277
1600-52	5-9/16" O.D. 2 Rails	80 lbs.	\$300

Model #1600-42
\$277 Powder Coated Finish

CONTEMPORARY BOLLARD POST BIKE RACK

The New Style Bollard Post bike rack provides users with 3 size options. Available in 3-1/2", 4-1/2", and 5-9/16" O.D. post sizes made of all galvanized steel construction. These feature double loops of 1-3/8" tubing and come complete with a factory installed aluminum cap. Both styles are available with optional powder coating for an additional charge. Powder coat colors on page 2.

Contemporary Bollard Post Bike Rack

Model	Description	Weight	Powder Coat Price	Galvanized Price
1605-32	3-1/2" O.D. - 2 Rails	40 lbs.	\$284	\$257
1605-42	4-1/2" O.D. - 2 Rails	56 lbs.	\$300	\$274
1605-52	5-9/16" O.D. 2 Rails	76 lbs.	\$342	\$316

Model #1605-32
\$284 Powder Coated Finish



PARKING BOLLARDS

Parking Bollards are 36" high and available in 4 sizes of galvanized steel including cap. Installed permanently or in sleeves with optional locking device. Powder coat colors on page 2.

Optional Ground Sleeve

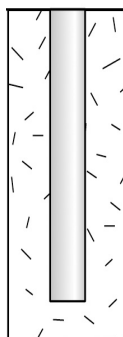

Parking Bollards

Model	Description	Weight	Powder Coat Price	Galvanized Price
1100-03	3-1/2" O.D. Post	38 lbs.	\$220	\$188
1100-04	4-1/2" O.D. Post	54 lbs.	\$233	\$201
1100-05	5-9/16" O.D. Post	74 lbs.	\$257	\$224
1100-06	6-5/8" O.D. Post	104 lbs.	\$285	\$251
1100-13*	3-1/2" O.D. Post with Ground Sleeve	68 lbs.	\$285	\$251
1100-14*	4-1/2" O.D. Post with Ground Sleeve	94 lbs.	\$411	\$374
1100-15*	5-9/16" O.D. Post with Ground Sleeve	124 lbs.	\$451	\$413
1100-16*	6-5/8" O.D. Post with Ground Sleeve	154 lbs.	\$511	\$470
LK	Locking Option for Ground Sleeve	N/A	\$69	\$69
CR	Chain Ring Welded to Bollard	N/A	\$25	\$25
DC1	Designer Plate Cover, 1 Piece	N/A	\$28	\$28
DC2	Designer Plate Cover, 2 Piece Wrap	N/A	\$53	\$53



PRECISION CUT CNC PLASMA PRODUCTS

Our facilities are equipped with state-of-the-art precision cutting CNC Plasma tables, capable of endless design and customization possibilities.

BRANDED RAINBOW BIKE RACK

Using our very popular Rainbow Bike Rack design, you now have the option to brand your business, town or school logo for everyone to see. This option is a fantastic way to increase your marketing campaign efficiency, and the elegance will leave a lasting impression on your potential clients. We use CNC Precision machines for this process and can reproduce almost any logo. (Depending on design complexity). Powder Coat colors on page 2.

For more information please contact us at
Sales@PWathletic.com



Model #1608-ENG
\$312 Powder Coated Finish





MEMORIAL BENCHES

CUSTOMIZATION



Our Custom Memorial benches are the perfect solution to add a special touch to your landscape. Whether it is to honor a fallen family member, or a special person in the community. We offer two different types of customization options to fit your needs and environment...and as always we use the highest quality materials on the market to ensure that your memorial will last a lifetime!

Engraved Composite Plank
 \$100 - 20 Characters per Line
 3 Lines per Plank



Honorarium or Memorial Message
 Choose a style of bench and add engraved plaque or plank
 Option A: Recycled Composite Plank Engraved + \$100
 Option B: Aluminum Plaque Engraved + \$140







Max: 3 lines per plaque or plank, Max: 20 characters per line

For more information please contact us at
Sales@PWathletic.com

Engraved Aluminum Plaque
 \$140 - 20 Characters/Line
 3 Line Maximum

MOUNTING OPTIONS

When applicable to the products you are ordering, please select your preferred mounting option and include the model option to the end of the model of your product.

- 
M1
 Permanent Mount
- 
M2
 Portable
- 
M3
 Round Surface Mount
- 
M4
 Rectangle Surface Mount
- 
DC1
 1 Piece
 \$28 per post
- 
DC2
 2 Piece
 \$53 per post
- 
DA
 Drop In Anchor
 \$16 Each



PO Box 1290, Salem IL 62881
140 N Gilbert, Mesa AZ 85203
1-800-687-5768, Fax: 618-548-2890
Sales@PWathletic.com

**FOR MORE INFORMATION VISIT OUR WEBSITE AT:
WWW.PWATHLETIC.COM**

A subsidiary of Americana Building Products Inc.

